



Journal of Advanced Research in Fluid Mechanics and Thermal Sciences

Journal homepage:

https://semarakilmu.com.my/journals/index.php/fluid_mechanics_thermal_sciences/index

ISSN: 2289-7879

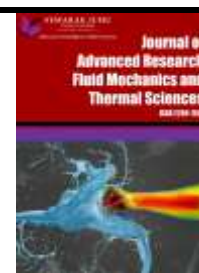

Design and Comparative Analysis of Vortex and Whirlpool Type Turbines in Assessing the Performance of Micro Hydro Power Plant

Indra Hermawan^{1,*}, Muhammad Idris¹, Iswandi Iswandi¹, Rahmad Syah²

¹ Department of Mechanical Engineering, Faculty of Engineering, Universitas Medan Area, Jl. Kolam No. 1, Medan Estate, Medan, Indonesia

² CoE-PUIN, Faculty of Engineering, Universitas Medan Area, Jl. Kolam No. 1, Medan Estate, Medan, Indonesia

ARTICLE INFO

Article history:

Received 20 March 2024

Received in revised form 22 June 2024

Accepted 3 July 2024

Available online 30 July 2024

Keywords:

Hydropower plant; turbine geometry; basin geometry; Gravity Water Vortex Power Plant (GWVPP)

ABSTRACT

Hydropower plants with a potential of 76,670 MW and mini/micro hydropower plants with a potential of 770 MW are crucial resources that are underutilized, with only 6% of this potential developed in Indonesia. This study aims to develop a laboratory-scale gravitational vortex power plant and evaluate its performance using two types of turbine blades: vortex and whirlpool. The focus is on determining the impact of blade geometry on power output and efficiency. The methodology involved using two turbine shapes: whirlpool and vortex and two conical basin angles: 67° and 58°. The water passage system included an upper reservoir, a water channel, and a turbine housing. Measurements of shaft rotation, electric current, voltage, and mass were recorded. The experiments, conducted at a constant flow rate of 6.75 L/s with head heights of 0.5 m and 0.67 m, revealed that whirlpool turbines generated higher average braking power compared to vortex turbines at both head heights. Specifically, whirlpool turbines produced an average braking power of 4.89 W at a head height of 0.67 m. Additionally, turbines with a 67° conical basin angle demonstrated better performance than those with a 58° angle. Generator power remained stable at a head height of 0.67 m for both turbine types but fluctuated significantly at a head height of 0.5 m, likely due to changes in water velocity and blade angle. The study concludes that whirlpool turbines are more efficient and generate higher average braking power than vortex turbines, especially at low water head heights. A conical basin angle of 67° enhances overall braking power performance. These findings suggest that whirlpool turbines are preferable for installations with lower hydraulic heads, while vortex turbines show increased efficiency at higher heads. This information can guide the selection of turbine types based on specific operational conditions, optimizing power generation efficiency.

1. Introduction

Hydroelectric Power Plants with a potential of 76,670 MW and Mini/Micro Hydro Power Plants with a potential of 770 MW are assets that must be utilized for the utmost prosperity of the people. Only about 6% of this potential has been developed. North Sumatra is a region with significant water energy potential, particularly for use as in mini/micro-hydroelectric power facilities [1]. A micro-

* Corresponding author.

E-mail address: indrahermawan@staff.uma.ac.id

<https://doi.org/10.37934/arfmts.119.2.1322>

hydro power plant captures energy on a small scale from falling water, such as that from steep mountain rivers, typically producing between 5 kW and 100 kW using the run-of-river flow [2]. In 1930, an Austrian scientist, Viktor Schaubberger, invented the vortex system hydropower facility. Franz Zotloterer transformed Viktor Schaubberger's concept into a vortex gravity power plant (GWVPP) by generating a water vortex in a cylindrical reservoir with an outlet at the bottom. An increase in the water's surface area will ultimately cause aeration [3]. Based on the rotational path followed by the water in the air-core vortex, he predicted that a vertical axis rotor situated at the centre of the vortex would generate rotational energy [4-6].

Each micro-hydropower facility has distinct benefits over the others. However, GWVPP has advantages over other types of micro-hydro power plants, including: operating at low rotation and causing no damage to the natural flow of water; easy installation and a quick return on investment; producing no harmful pollutants; and operating at low rotation [6]. It is superior in terms of power generation because water operates simultaneously on all blades. can be installed along the river flow, eliminating the need to construct dams; installation costs and transmission losses associated with transmission lines are minimized; has very few moving parts, resulting in low maintenance and operating costs; components can be manufactured locally. Micro-hydro turbines with low heads (0.7–3 m) and easy installation in irrigation canals and rivers do not require a large water storage reservoir and can be installed in rivers with the same flow without affecting the flow of subsequent turbines in the system.

Since 1930, numerous researchers with related interests have conducted numerous studies on this topic, and there are still a significant number of such studies ongoing. Zhang *et al.*, [7] observed that frequent transitions between operational modes for reversible pump turbines result in a variety of instability issues, including significant pressure fluctuations, shaft oscillation, and impeller damage. The instability is a result of the vortices generated in the ducts of the reversible pump turbine in generation mode [7]. Kim *et al.*, [8] examined the effect of the number of blades on vortex turbines with 5, 6, 8, and 10-blade turbines, while they investigated the effect of tube drafts with straight and conical designs. While maintaining a stable vortex air core, the eight-blade turbine achieves a maximum efficiency of 57%. The addition of a small draft tube to the vortex basin increases efficiency by up to 60% due to its ability to progressively recover pressure upon discharge [7]. Nishi *et al.*, [9,10] investigated the effect of flow rate on the efficacy of a gravity vortex-type water turbine by analysing free surface flow experiments. Using the analysis results with the loss analysis method and quantitatively evaluating hydraulic losses, it was determined that the effective head and turbine efficiency increased as the flow rate increased; consequently, the turbine output increased at a rate greater than the flow rate increase [9,10]. Moreover, it was discovered that among the losses that occur in water turbines, tank losses and tank output losses are the most significant, followed by friction losses in the tank, whereas friction losses in the runner are negligible.

Many studies have discussed the influence of various parameters such as impact angle, blade angle, and number of blades on the performance of gravitational water vortex turbines, Nevertheless, reports on the effects comparing turbine type and flow output line on turbine performance are very limited. This research aims to develop a laboratory-scale single-stage gravity vortex power plant as a testing facility for further research. The performance of the developed hydropower plant is checked with two types of turbine blades namely whirlpool and vortex and two cone-shaped output channels: 67° and 58° to determine their effect on power generation and efficiency. The study underscores the potential of GWVPP for sustainable micro-hydropower development, highlighting its advantages in various hydraulic conditions and installation environments.

2. Methodology

The form and dimensions of the basin impact the turbine's efficacy [11]. According to Khan *et al.*, [12], a larger receptacle diameter reduces the vortex height. The water's velocity decreases due to friction as it travels along the basin's floor. This hurts performance. The geometry of the runner also impacts the amount of energy a turbine generates. Saleem *et al.*, [13] examined a variety of blade configurations and morphologies, including blade radius curvature, blade inclination, hub diameter, and blade aspect ratio. However, Dhakal *et al.*, [14] investigated the effect of aluminium and steel operating materials on power generation. According to research, lighter materials generate up to 34.79 per cent more power. There are two turbine shapes tested in this experiment, as shown in Figure 1. Figure 1(a) is called a turbine with a whirlpool-type shape and Figure 1(b) is called a turbine with a vortex-type shape.

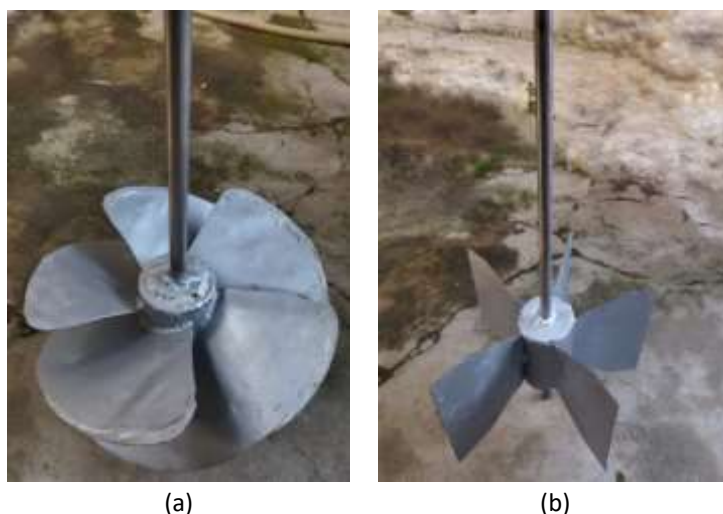

Fig. 1. Turbine Type: (a) Whirlpool turbine, (b) Vortex turbine

As shown in Figure 2, there are two varieties of output channels (conical basin) for the water flowing through the turbine in this study: conical with an angle of 67° (outlet diameter 64 mm) and 58° (51 mm).

Figure 3 shows the water passage on the test. The lower reservoir holds water. A pump pushes water through a conduit and into the upper reservoir (3). Water from the upper reservoir travels through the water channel to the turbine housing (2) and turns the turbine (5). The shaft of the turbine transmits its rotation to the pulley (9) via a belt (11), which in turn transmits the pulley's rotation to the generator shaft (6). The tachometer measures the shaft's rotational speed. Meanwhile, a multimeter is used to measure voltage and current. The water flow rate is manually determined using a stopwatch and a measurement bucket.

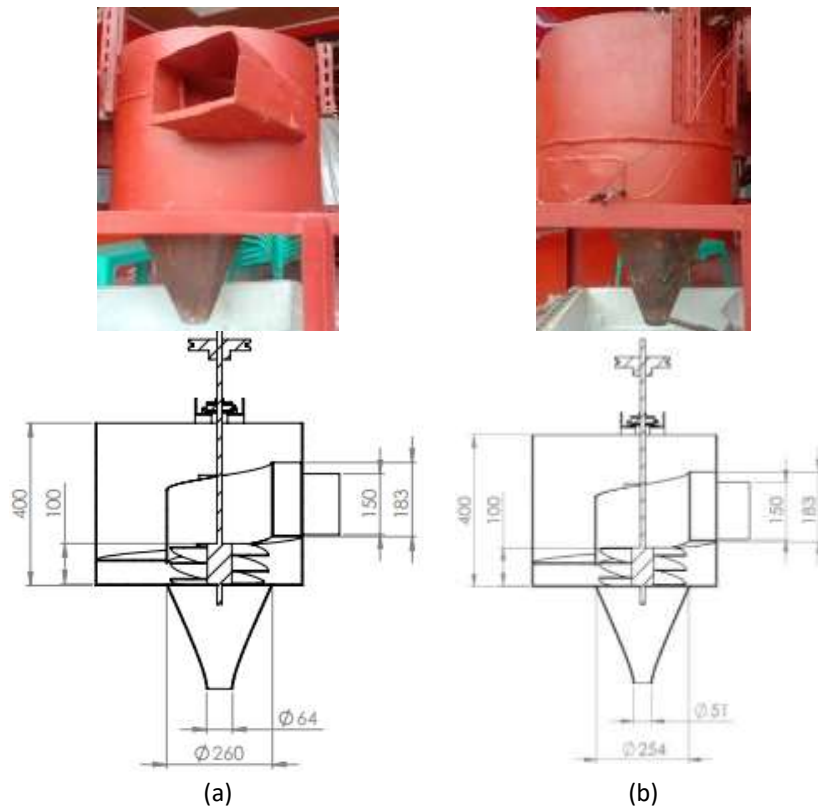
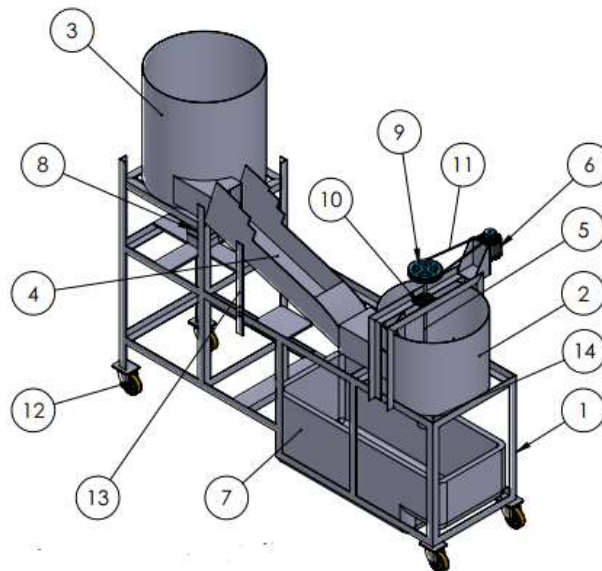

Fig. 2. Conical basin (a) conical with an angle of 67°, (b) conical with an angle of 58°



- | | |
|--------------------|--------------------|
| 1. Frame | 8. Jack |
| 2. Turbine Housing | 9. Pulleys |
| 3. Upper Reservoir | 10. Bearings |
| 4. Water channel | 11. Belts |
| 5. Turbine | 12. Wheels |
| 6. Generators | 13. Height Control |
| 7. Lower Reservoir | 14. Outlet |

Fig. 3. Generator Prototype the water passage on the test

The following formula should be used to calculate the hydraulic energy produced by hydroelectric power facilities (P, W) [15-17]

$$P_h = \rho \cdot g \cdot Q \cdot H \quad (1)$$

where ρ represents the density of water (997 kg/m³), g represents gravity (9.81 m/s²), Q represents the flow rate (m³/s), and H represents the height difference or head in the vortex power plant (m). The formula for calculating turbine power is [4,5,16]

$$P_T = \tau \omega \quad (2)$$

Where τ is the torque (Nm) and ω is the turbine's rotational speed (rad/s). Where exactly [18]

$$\tau = rF \quad (3)$$

Torque is applied by braking force on the axle through a belt pulley system, and the brake force value is recorded on a spring balance. The braking force (F) multiplied by the pulley radius (r) produces the braking torque (τ) [13].

$$\omega = \frac{2\pi n}{60} \quad (4)$$

n is the shaft rotation (rpm), which is measured using a tachometer. Experimental mechanical efficiency (η_{exp}) can be calculated by the equation [18]

$$\eta_{exp} = \frac{P_T}{P_h} \times 100\% \quad (5)$$

3. Results

The experiment was conducted in a laboratory with a fluid temperature of 29°C. The variables of shaft rotation, electric current, voltage, and mass 1 and 2 are measured and then the measurement results are recorded. Table 1 and Table 2 show the average value of the measurement results of the experiment and the calculation results, where the experiment was carried out for 1 hour. The flow rate at the water inlet to the turbine was kept constant at 6.75 L/s for all experiments the heads used were 0.5 m and 0.67 m and the pulley radius was 0.076 m.

Table 1
 Average test results with head = 0.5 m

Turbine Type	Conical Basin (°)	Voltage (Volt)	Current (Amp)	Rotation (rpm)	Mass 1 (kg)	Mass 2 (kg)	Power Generator (W)	Rotation Speed (rad/s)	Torsi (N.m)	Brake Power (W)
Vortex	58	3.07	0.47	97.34	0.17	0.39	1.43	10.19	0.17	1.72
	67	4.05	0.66	109.78	0.27	0.69	2.69	11.49	0.32	3.64
Whirpool	58	2.94	0.55	96.00	0.17	0.61	1.61	10.05	0.33	3.30
	67	4.59	0.56	114.28	0.25	0.80	2.56	11.96	0.41	4.89

Table 2

Average test results with head = 0.67 m

Turbine Type	Conical Basin (°)	Voltage (Volt)	Current (Amp)	Rotation (rpm)	Mass 1 (kg)	Mass 2 (kg)	Power Generator (W)	Rotation Speed (rad/s)	Torsi (N.m)	Brake Power (W)
Vortex	58	3.46	0.55	93.66	0.16	0.38	1.91	9.80	0.16	1.60
	67	3.97	0.76	120.43	0.43	1.23	3.01	12.61	0.60	7.52
Whirlpool	58	3.06	0.65	111.09	0.21	0.62	1.99	11.63	0.31	3.57
	67	5.75	0.63	144.64	0.27	0.80	3.63	15.14	0.40	5.99

From Table 1 and Table 2, it can be seen that with a head of 0.5 m and 0.67 m, plants using the whirlpool turbine type produce better average braking power compared to using vortex turbine types. For each type of turbine, a conical basin angle of 67° provides better average braking power results than a conical basin with an angle of 58°. This means that the turbine type and the angle of the conical basin affect the braking power generated.

3.1 Micro-Hydro Power Plant Performance

A comparison of the performance of micro-hydro power plants using vortex and whirlpool turbine types for different head heights with a conical basin of 58 degrees is shown in Figure 4 and Figure 5, which display the power and efficiency results.

In Figure 4(a), the graph illustrates the power generated relative to a head of 0.67m. It compares two types of power: Generator Power and Brake Power, each under two different turbine conditions: Vortex and Whirlpool. Generator Power (Vortex) exhibits greater variability compared to other power types, peaking around the 5th experiment, while Generator Power (Whirlpool) remains relatively stable but declines in the 5th and 9th experiments. Brake Power for both Vortex and Whirlpool conditions remains relatively constant at approximately 1.00 W. Generator Power fluctuates for both Vortex and Whirlpool turbines but remains below 3 W, while Brake Power varies, particularly for Whirlpool, reaching almost 6 W. Overall, the graph highlights the contrasting stability and output efficiency between Vortex and Whirlpool turbines under similar hydraulic conditions. The Whirlpool turbine, despite some fluctuations, tends to provide more stable generator power, whereas the Vortex turbine exhibits more erratic power output while maintaining consistent brake power performance. This implies that each turbine type may have specific conditions under which it performs optimally.

Figure 4(b) displays a graph illustrating the power generated by a head of 0.5 m. The graph compares two types of power: generator power and brake power for vortex and whirlpool turbines, respectively. It indicates that generator power (vortex) remained constant at around 1.6 W throughout all experiments, while generator power (whirlpool) showed minor fluctuations before stabilizing at the same value. Brake power (whirlpool) increased significantly from the second to the eighth experiment before declining. Brake power (vortex) followed a clear up-and-down pattern. Overall, the graph demonstrates that both turbine types can achieve comparable generator power outputs at a lower head height, although Whirlpool shows more variability in brake power performance. The observed brake power patterns suggest that different experimental setups or operational conditions could significantly impact turbine performance, underscoring the importance of maintaining consistent conditions to achieve optimal outputs.

Figure 4(a) and Figure 4(b) illustrate that braking power surpasses the mean of generator power. These graphs depict variations in power production at different head levels (0.67 m and 0.5 m). At a 0.67 m head, both vortex and whirlpool power generators remained stable with nearly constant

values throughout the experiment. However, at a 0.5 m head, generator power exhibited more significant fluctuations. Brake power exhibited a similar pattern in both scenarios. Fluctuations in generator power at the 0.5-meter head may stem from various factors, including changes in water speed, blade angle, or electric current.

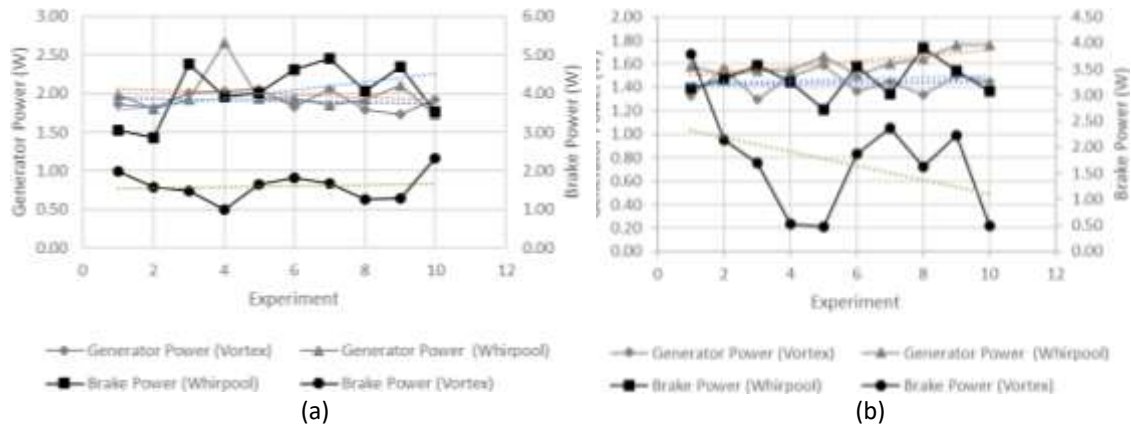

Fig. 4. Power result with conical basin 58 degrees: (a) Head = 0.67 m, (b) Head = 0,5 m

The data presented in Figure 5(a) reveals that power generators, specifically the Vortex type, exhibited greater variations compared to the other categories during the experiment. In the fourth experiment, the generator power of the Vortex peaked at around 10 W, while the brake power of the same type of generator reached its highest value but was lower at 6 W. Meanwhile, the generator power and brake power of the Whirlpool type remained stable throughout the experiment with minor fluctuations. The graph also displays the results of multiple experiments conducted under both vortex and whirlpool conditions. The generator power exhibited fluctuations with its highest peaks during the fourth and eighth experiments. On the other hand, the brake power showed little improvement in whirlpool conditions, while it remained stable in vortex conditions. In Figure 5(b), it is evident that the braking power produced fluctuating results, while the generator power remained stable. The Whirlpool turbine type generated higher braking power than the Vortex turbine type, with an average of 4.89 W. Generally, whirlpool turbines demonstrate better power performance compared to vortex turbines.

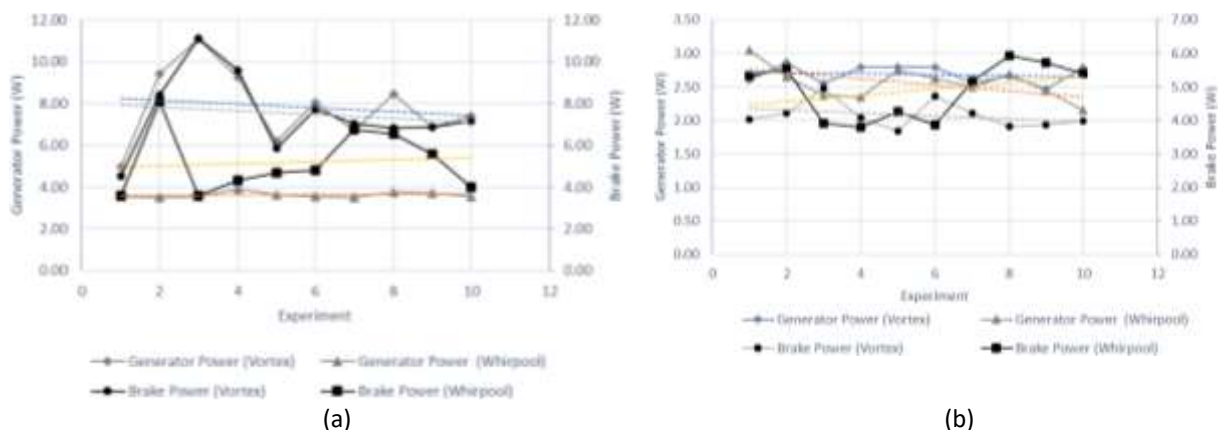

Fig. 5. Power result with conical basin 67 degrees: (a) Head = 0.67 m, (b) Head = 0.5 m

In Figure 6(a), the graph shows that it is evident that the Whirlpool turbine type consistently outperforms the Vortex turbine in terms of efficiency at both head heights tested. Additionally, both turbine types show higher efficiency at the lower head height of 0.5 m compared to 0.67 m, which

suggests that lower head heights are more favorable for efficiency in these conditions. Furthermore, Figure 6(b) shows that the bar graph presented illustrates the comparative efficiencies of Vortex and Whirlpool turbines under two different hydraulic head conditions—0.5 meters and 0.67 meters. The graph reveals that the performance of these turbines varies significantly with changes in the head height. For the Vortex turbine, the efficiency at a head of 0.5 meters is recorded at 11.12%. When the head is increased to 0.67 meters, the efficiency shows a notable improvement, rising to 17.12%. This increase suggests that the Vortex turbine is more effective at converting hydraulic energy into mechanical energy at higher head conditions, possibly due to design characteristics that better exploit the increased hydraulic pressure [16]. Conversely, the Whirlpool turbine demonstrates a different pattern. It shows an efficiency of 14.91% at the lower head of 0.5 meters, which slightly decreases to 13.65% when the head is raised to 0.67 meters. This indicates that the Whirlpool turbine may have optimizations that favor lower head conditions, potentially making it more suitable for environments where the hydraulic head is relatively low. The analysis of these efficiency metrics is crucial for determining the appropriate turbine type based on specific operational conditions. The Vortex turbine's increased efficiency at higher heads makes it an attractive option for situations where such conditions prevail. Meanwhile, the Whirlpool turbine's better performance at lower heads suggests its suitability for installations where the hydraulic pressure is less intense.

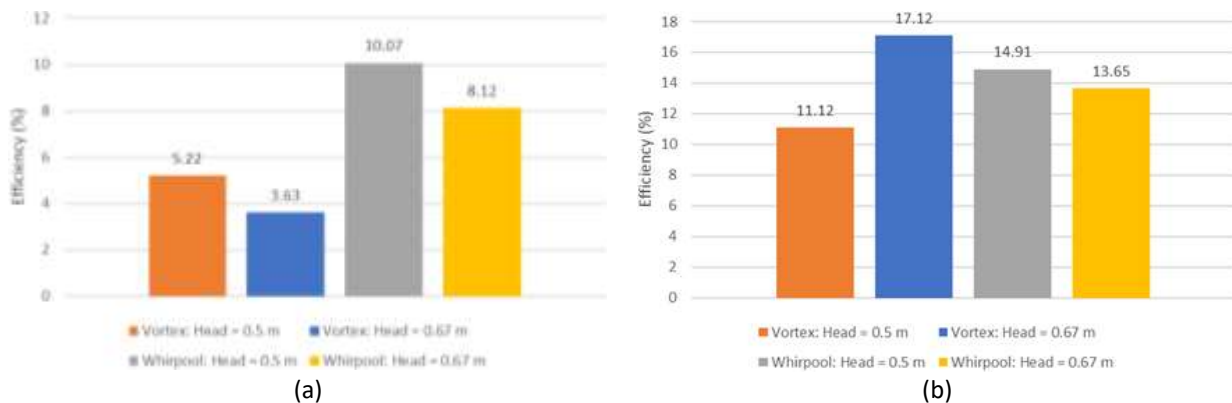

Fig. 6. Power Efficiency: (a) conical basin 58 degrees, (b) conical basin 67 degrees

4. Conclusions

Whirlpool turbines generate superior average braking power than vortex turbines at 0.5m and 0.67m water head heights. A conical basin angle of 67 degrees provides better overall braking power than a 58-degree angle for both types of turbines. Throughout the experiment, the generator power remained stable at a head of 0.67 m for both the vortex and whirlpool. At a head of 0.5 meters, the generator power experiences significant fluctuations, possibly due to changes in water velocity, blade angle, or electric current. The average braking power of the whirlpool turbine was 4.89 W, higher than that of the vortex turbines in the experiment. Whirlpool turbines are more efficient than vortex turbines, especially at low water head heights. The power output of vortex turbines tends to fluctuate more than that of whirlpool turbines. Turbine efficiency fluctuates more for vortex turbines than whirlpool turbines, especially at a water head height of 0.5 m. Experimental results indicate that whirlpool turbines deliver superior braking power performance and efficiency compared to vortex turbines, especially when the conical reservoir angle is set at 67°. Additionally, the fluctuation of power generated by both types of turbines is influenced by variations in the water head's height.

Acknowledgement

This research was funded by a grant from the Ministry of Education, Culture, Research, and Technology of the Republic of Indonesia (DRTPM Contract Number: 177/E5/PG.02.00.PL/2023, 027/LL1/AI/04.03/2023, 1856/LP2M/03.1.1/VII/2023).

References

- [1] Ditjen SDA. "Potensi PLTA di Indonesia sebesar 76.670 Megawatt." *Direktorat Jenderal Sumber Daya Air, Balai Wil. Sungai Sumatera I*, 2014. <https://sda.pu.go.id/balai/bwssumatera1/article/potensi-plta-di-indonesia-sebesar-76670-megawatt>.
- [2] Ofosu, Robert Agyare, K. K. Kaberere, J. N. Nderu, and S. I. Kamau. "Design of BFA-optimized fuzzy electronic load controller for micro hydro power plants." *Energy for Sustainable Development* 51 (2019): 13-20. <https://doi.org/10.1016/j.esd.2019.04.003>
- [3] Wanchat, Sujate, Ratchaphon Suntivarakorn, Sujin Wanchat, Kitipong Tonmit, and Pongpun Kayanyiem. "A parametric study of a gravitation vortex power plant." *Advanced Materials Research* 805 (2013): 811-817. <https://doi.org/10.4028/www.scientific.net/AMR.805-806.811>
- [4] Dhakal, Sagar, Ashesh B. Timilsina, Rabin Dhakal, Dinesh Fuyal, Tri R. Bajracharya, Hari P. Pandit, Nagendra Amatya, and Amrit M. Nakarmi. "Comparison of cylindrical and conical basins with optimum position of runner: Gravitational water vortex power plant." *Renewable and Sustainable Energy Reviews* 48 (2015): 662-669. <https://doi.org/10.1016/j.rser.2015.04.030>
- [5] Bajracharya, Tri Ratna, Shree Raj Shakya, Ashesh Babu Timilsina, Jhalak Dhakal, Subash Neupane, Ankit Gautam, and Anil Sapkota. "Effects of geometrical parameters in gravitational water vortex turbines with conical basin." *Journal of Renewable Energy* 2020, no. 1 (2020): 5373784. <https://doi.org/10.1155/2020/5373784>
- [6] Maika, Nosare, Wenxian Lin, and Mehdi Khatamifar. "A review of gravitational water vortex hydro turbine systems for hydropower generation." *Energies* 16, no. 14 (2023): 5394. <https://doi.org/10.3390/en16145394>
- [7] Zhang, Yu-ning, Kai-hua Liu, Jin-wei Li, Hai-zhen Xian, and Xiao-ze Du. "Analysis of the vortices in the inner flow of reversible pump turbine with the new omega vortex identification method." *Journal of Hydrodynamics* 30 (2018): 463-469. <https://doi.org/10.1007/s42241-018-0046-1>
- [8] Kim, Min-Sung, Dylan S. Edirisinghe, Ho-Seong Yang, S. D. G. S. P. Gunawardane, and Young-Ho Lee. "Effects of blade number and draft tube in gravitational water vortex power plant determined using computational fluid dynamics simulations." *Journal of Advanced Marine Engineering and Technology* 45, no. 5 (2021): 252-262. <https://doi.org/10.5916/jamet.2021.45.5.252>
- [9] Nishi, Yasuyuki, Daichi Sukemori, and Terumi Inagaki. "Performance and flow field of gravitation vortex type water turbine using volute tank." *International Journal of Fluid Machinery and Systems* 14, no. 3 (2021): 229-246. <https://doi.org/10.5293/IJFMS.2021.14.3.229>
- [10] Nishi, Yasuyuki, Ryouta Suzuo, Daichi Sukemori, and Terumi Inagaki. "Loss analysis of gravitation vortex type water turbine and influence of flow rate on the turbine's performance." *Renewable Energy* 155 (2020): 1103-1117. <https://doi.org/10.1016/j.renene.2020.03.186>
- [11] Vinayakumar, B., Rahul Antony, V. A. Binson, and Sunny Youhan. "Experimental and numerical study on gravitational water vortex power plant for small water bodies." *e-Prime-Advances in Electrical Engineering, Electronics and Energy* (2024): 100460. <https://doi.org/10.1016/j.prime.2024.100460>
- [12] Khan, Nauman Hanif, Taqi Ahmad Cheema, Javed Ahmad Chattha, and Cheol Woo Park. "Effective basin-blade configurations of a gravitational water vortex turbine for microhydropower generation." *Journal of Energy Engineering* 144, no. 4 (2018): 04018042. [https://doi.org/10.1061/\(ASCE\)EY.1943-7897.0000558](https://doi.org/10.1061/(ASCE)EY.1943-7897.0000558)
- [13] Saleem, Abdul Samad, Taqi Ahmad Cheema, Rizwan Ullah, Sarvat Mushtaq Ahmad, Javed Ahmad Chattha, Bilal Akbar, and Cheol Woo Park. "Parametric study of single-stage gravitational water vortex turbine with cylindrical basin." *Energy* 200 (2020): 117464. <https://doi.org/10.1016/j.energy.2020.117464>
- [14] Dhakal, R., T. R. Bajracharya, S. R. Shakya, B. Kumal, K. Khanal, S. J. Williamson, S. Gautam, and D. P. Ghale. "Notice of Violation of IEEE Publication Principles: Computational and experimental investigation of runner for gravitational water vortex power plant." In *2017 IEEE 6Th International Conference On Renewable Energy Research And Applications (ICRERA)*, pp. 365-373. IEEE, 2017. <https://doi.org/10.1109/ICRERA.2017.8191087>
- [15] Timilsina, Ashesh Babu, Sean Mulligan, and Tri Ratna Bajracharya. "Water vortex hydropower technology: a state-of-the-art review of developmental trends." *Clean Technologies and Environmental Policy* 20 (2018): 1737-1760. <https://doi.org/10.1007/s10098-018-1589-0>
- [16] Ullah, Rizwan, and Taqi Ahmad Cheema. "Experimental investigation of runner design parameters on the performance of vortex turbine." *Engineering Proceedings* 23, no. 1 (2022): 14.

- <https://doi.org/10.3390/engproc2022023014>
- [17] Ofosu, Robert Agyare, E. Normanyo, K. K. Kaberere, S. I. Kamau, and E. K. Otu. "Design of an electronic load controller for micro hydro power plant using Fuzzy-PI controller." *Cogent Engineering* 9, no. 1 (2022): 2057115. <https://doi.org/10.1080/23311916.2022.2057115>
- [18] Sritram, Piyawat, and Ratchaphon Suntivarakorn. "The efficiency comparison of hydro turbines for micro power plant from free vortex." *Energies* 14, no. 23 (2021): 7961. <https://doi.org/10.3390/en14237961>