



SEMARAK ILMU
PUBLISHING
202103268166(003316878-P)

Journal of Advanced Research in Applied Sciences and Engineering Technology

Journal homepage:
https://semarakilmu.com.my/journals/index.php/applied_sciences_eng_tech/index
ISSN: 2462-1943



Factors Affecting the Implementation of the Digital Twins in the Construction Industry: An Interpretive Structural Modelling Analysis

Wang Jiao^{1,2}, Khoo Terh Jing^{1,*}, Muneera Esa¹, Sun Hui¹

¹ School of Housing, Building and Planning, Universiti Sains Malaysia, 11800 Pulau Pinang, Malaysia

² Department of Construction Engineering, Guizhou Communication Polytechnic University, Guizhou, China

ARTICLE INFO

Article history:

Received 12 June 2024

Received in revised form 30 October 2024

Accepted 12 November 2024

Available online 10 December 2024

Keywords:

Digital Twins; Construction Industry;
Interpretive Structural Modeling (ISM)
Analysis

ABSTRACT

With the extensive use of digital technologies, the modern construction industry has made progress in improving productivity and safety. Despite this, construction productivity remains among the lowest in the industry. With the development of Industrial Revolution 4.0, the construction industry has also benefited from it, forming the idea behind Construction 4.0, which is founded on: the digitization of the construction sector and the industrialization of the construction procedure. The current use of digital twins in the construction industry is considered among the most successful and influential ways to achieve Construction 4.0, optimize construction links, and improve coordination among stakeholders. Many factors are impacting the construction industry's adoption of digital twins. Previous studies have failed to propose a practical model to facilitate the implementation of digital twins in the construction industry. This study fills this gap. First, this study conducted a systematic literature review (SLR) based on Web of Science and Scopus databases to identify negative and positive factors. SLR identifies four aspects of factors, including technical factors, stakeholder factors, external factors, and economic factors. A conceptual model is then proposed using an interpretive structural modeling analysis approach. The model is used to describe the interaction of these factors in digital twins implementation, and finally, recommendations are made to mitigate the negative factors based on the model. This conceptual model helps guide digital twin implementation in the construction industry and helps build a knowledge system of digital technology. The findings will support practitioners in the construction industry using or planning to use digital twins.

1. Introduction

With the progress of technology and science, many management methods and advanced technologies have been introduced into industrialized construction, promoting the adoption of construction innovation and industrialization [1]. Industry 4.0 integrates a series of emerging technologies, including building information modelling (BIM), the internet of things (IoT), digital twins (DTs), cloud computing, and big data. The construction industry (CI) has also benefited from this

* Corresponding author.

E-mail address: terhjing@usm.my

<https://doi.org/10.37934/araset.53.2.263282>

development, resulting in the concept of "Construction 4.0." The purpose of applying digital technology is to improve operational efficiency and increase productivity in industrial environments [2]. Digital twins as a common Industry 4.0 production technique, are generally considered to be "high-fidelity virtual copies of physical assets with real-time two-way communication for simulation purposes and product service-enhanced decision-making aids." DTs are generally considered versatile and scalable solutions that provide a cost-effective approach to resource tracking, and modelling includes two-way real-time communication for scenario simulation and solution creation. DTs are now key facilitators for advancements related to Construction 4.0 [3].

By reviewing previous research, most of the literature shows that research on DTs focuses more on the manufacturing, computer science, automation control, and healthcare industries. Over the past few years, interest in this topic has increased. from academia and industry in the use of DTs systems in construction [3]. According to reputable research firm Markets and Markets, the size of the global DTs market was estimated at \$ 3.1 billion in 2020 and is expected to grow to USD 48.2 billion by 2026. It is anticipated to expand at 58% CAGR throughout the projected period [4]. To address the persistent challenges of low productivity and underperformance in construction projects, researchers and professionals in the Architecture, Engineering, and Construction (AEC) domains have been searching for optimal solutions [5]. Even with such incremental changes, construction productivity remains among the lowest in the industry [6]. One significant challenge in modernizing the CI is its resistance to technological advancements. Despite extensive efforts by researchers to ascertain the potential of DTs in addressing industrial issues, their implementation in the construction sector has been minimal. This is because of the limited use of digital technologies in developing DTs for smart buildings [7]. In the previous study conducted by Su *et al.*, [8], DTs were applied to construction supply chain coordination, and a real-time logistics simulation method based on DTs was developed, which can accurately predict potential logistics risks and delivery time. It tested the method in a case project. In subsequent research, DTs were applied to communication between construction stakeholders, and a traceable data communication method for the construction industry based on DT and blockchain was developed. Finally, the proposed method was verified through a project.

Researchers believe that the study and implementation of DT can help the construction industry move forward, but the existing literature shows that 1. The research on the implementation of DT in CI comes only from a single literature review of implementation barriers and driving factors, and 2. There is no in-depth study of the correlation between these factors, which means that previous studies cannot reveal these key factors or describe the relationship between them. The incompleteness of related research and the complexity of the CI itself make it difficult for industry practitioners to make the most appropriate decisions to implement DT to improve productivity and safety. This study collects and organizes existing research, conducts sufficient content analysis, and establishes an explanatory structural model based on the correlation of each element, providing practitioners with stronger background knowledge on DT implementation and researchers with a stronger foundation for the future development of literature.

The remainder of this paper is structured as follows: The second part clarifies that the research design is divided into five steps, introduces the material collection and statistical steps of the systematic literature review (SLR) in the study. The third section based on the content analysis of the SLR, a list of factors affecting the implementation of DTs in the CI was compiled, and a summary grouping and specific descriptive analysis were conducted. The fourth part uses Interpretive Structural Modelling (ISM) for further analysis and formulates a model. The fifth part analyzes the structural model and factor classification results to identify strategies to enhance current DT-related practices. Finally, the sixth part discusses the limitations of this work, as well as implications for

practice and research, and suggestions for future research directions. This study fills the research gap in the existing literature regarding the lack of in-depth exploration of the relationships between factors influencing the implementation of Digital Twins (DTs). By using the ISM method, a hierarchical structure model of these factors is constructed, systematizing their roles. This provides a clearer and more structured framework for analyzing the influencing factors, serving as practical guidance for the digital transformation of the construction industry.

2. Methodology

Figure 1 illustrates the research design of this study. To fulfill this study's objectives, the following research work is planned based on the above research questions. First, through SLR and content analysis, a large number of published relevant literature on DTs applications was reviewed, and a preliminary list of factors was compiled (Figure 2). Next, we determined the factors influencing how DTs are implemented in the CI and evaluated the interrelationships of these factors. If there were different opinions, semi-structured interviews were used to conduct group interviews with several DTs research experts. The critical influencing factors were identified, and then the ISM analysis method was used to build a structural model to visualize the interaction of the identified influencing factors. The method used in this study included the four steps listed in Figure 1 such as material collection, descriptive analysis, category selection, and material evaluation [9]. Each stage is described in the following subsections.

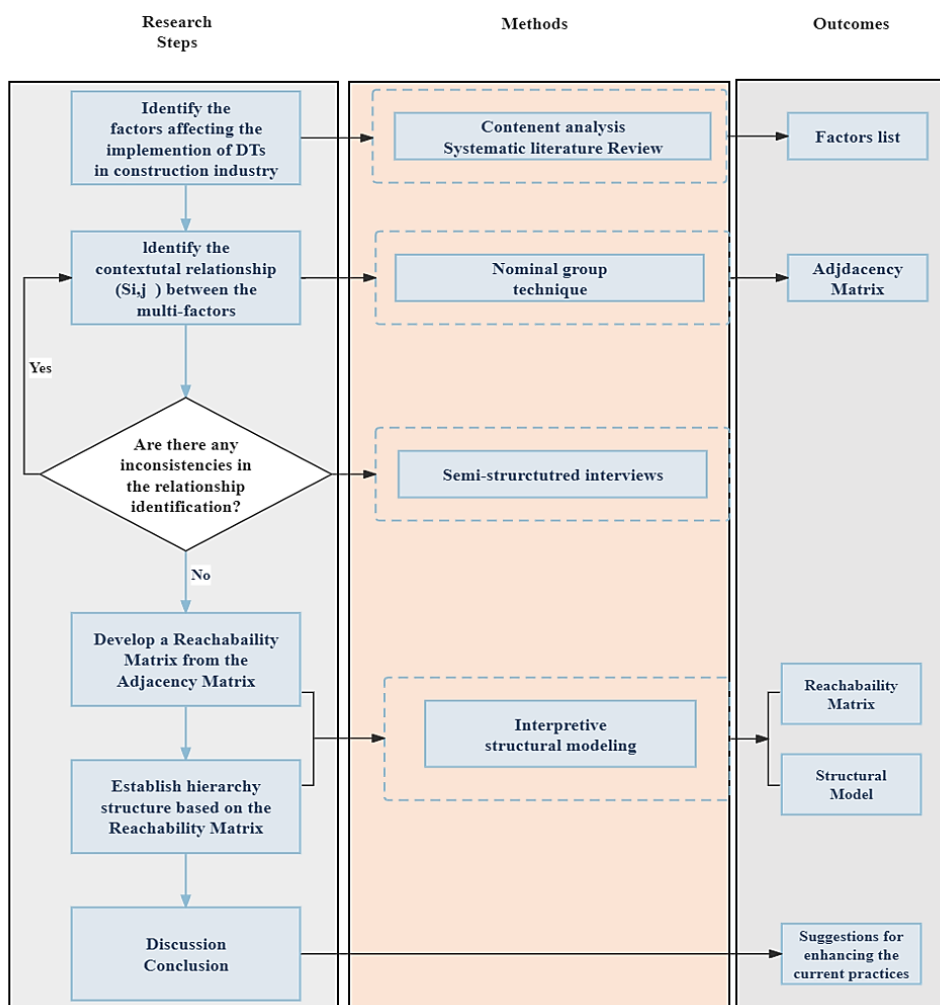

Fig. 1. Research design

2.1 Material Collection

Scopus and Web of Science databases were employed in the initial search as they have broader coverage [10]. Gathering data from multiple databases ensures more inclusive results. To avoid multiple databases offering the same documents, Endnote was used to filter out duplicate documents. To obtain a large number of papers, an extensive search was first carried out with the proper Boolean operators and keywords: Period: 2017-2024; Language: English; Type= "Article" OR "Review"; Source= "Journal"; Subject Category= "Engineering," DTs is considered relatively new in the CI, so the year limit is 2017-2024. Select "Article" or "Review" as the document type as They offer the most reliable and significant information sources [11]. Reviews of books, presentations, discussions, and seminar papers were not included in this investigation, and the language type was limited to English

The original search version string was relatively simple, and the search string was expanded using several iterations. During iterations, new keywords are added to consider synonyms based on new developments and the content of the literature, making the search string more thorough. Table 1 shows the search string used in the search. The search keywords were derived from the Research Questions (RQs) to ensure their consistency with the research topic and from the analysis of the most relevant literature content to accurately answer these questions. The search string underwent three search iterations to obtain relevant literature on factors affecting the implementation of DTs in the CI. Table 2 lists the number of documents obtained from the database in each iteration. As can be seen from the results, the number of publications on the topic continues to increase, demonstrating a continued upward trend in interest in DTs applications among researchers and industry practitioners [12,13].

Table 1
 Search strings used for the literature study

Sources	Search string
Scopus	TITLE-ABS-KEY ("digital twin*" OR "digital shadow" OR "digital twins*" OR "virtual twin" OR "virtual shadow" OR "Cyber-Physical System") AND TITLE-ABS-KEY (construction OR construction industry OR building OR architecture OR engineering OR article OR review) AND TITLE-ABS-KEY (barriers OR obstacles OR enable* OR driver) AND LANGUAGE (English) AND YEAR (2018-2024)
Web of Science	TS = (((("digital twin*" OR "digital shadow" OR "digital twins*" OR "virtual twin" OR "virtual shadow" OR "Cyber-Physical System" OR "CPS")) AND ((construction OR construction industry OR building OR architecture OR engineering OR article OR review) AND (barriers OR obstacles OR enable* OR driver)) AND LANGUAGE: (English)AND YEAR (2018-2024)

Table 2
 Number of hits at the iteration of the literature search

Sources	Iteration1 02/05/2023	Iteration2 28/08/2023	Iteration3 21/12/2023
Scopus	318	415	557
Web of Science	375	483	636
Total (removing duplicates)	648	859	1193
Growth (form iteration1)		+32.6%	+38.9%

Following the above search, the total number of documents were collected was 1193. After removing duplicates, this number was reduced to 1037 articles. The studies underwent a two-step screening procedure carried out by two individuals on the study team to reduce the risk of bias. The first phase was reading each article's title and abstract and then conducting an initial screening based on their significance for the RQs. Papers that did not mention enablers or barriers to DTs

implementation in the title or abstract were excluded. If the article's topic was mentioned in the abstract, including enablers or barriers to DTs implementation, it was retained for the next round even if any specific factors in the abstract were not explicitly mentioned. In this step, 932 papers were discarded, leaving 105 articles that could be pertinent for the subsequent stage of the intensive literature selection process. This approach aimed to identify relevant papers that only mentioned enablers or barriers to the implementation of digital technologies throughout the text. This process yielded a final list of 35 pertinent papers. The procedure for choosing articles from the first iteration to the last iteration is displayed in Table 1, Table 2 and Figure 2.

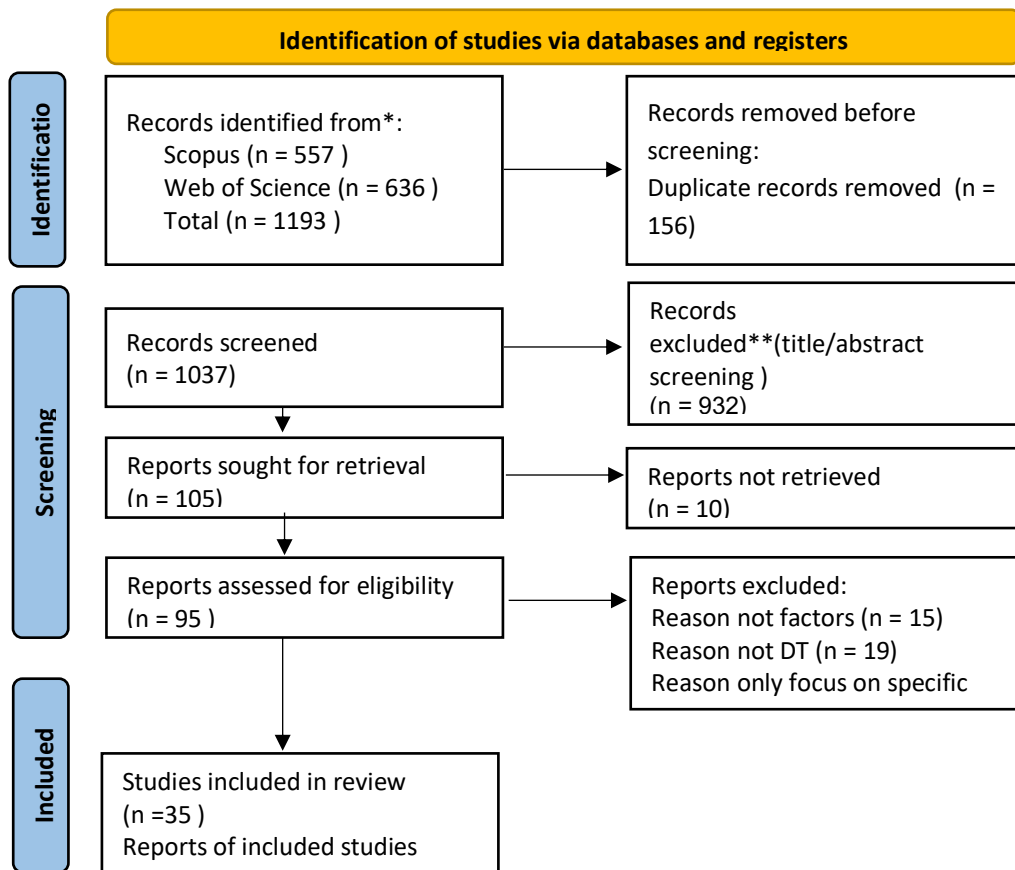

Fig. 2. Flow diagram for systematic literature reviews

2.2 Descriptive Analysis

Figure 3 shows the main information in the selected literature. The selected articles were all published between 2019 and 2024, and the final number of documents was 35, including 23 journal papers and 12 literature reviews. The average annual publication rate of articles studying the factors influencing DTs was less than two. This shows that research on influencing factors is relatively limited, which also proves the significance of this study. Figure 4 shows that among the 35 articles, the number of publications on the topic of DTs has shown steady growth in developed countries such as Australia, the United Kingdom, and the United States, while research on DTs in developing countries such as China and Malaysia will also gradually increase from 2022. This number has reached or even exceeded that of developed countries. Starting from 2021, the data show a substantial increase in China, which shows that China has great interest and potential in the application of DTs in the CI. Figure 5 shows the research cooperation relationships between countries. Developed countries mostly cooperate with the United States, whereas developing countries are dominated by China and

Malaysia. Figure 6 shows the Most Relevant Sources. The first is buildings, and the second and third are applied Sciences, Journal of Information Technology in Construction.

Description	Results
MAIN INFORMATION ABOUT DATA	
Timespan	2019:2024
Sources (Journals, Books, etc)	23
Documents	35
Document Average Age	1.97
Average citations per doc	49.09
DOCUMENT CONTENTS	
Keywords Plus (ID)	251
Author's Keywords (DE)	137
AUTHORS	
Authors	148
Authors of single-authored docs	2
AUTHORS COLLABORATION	
Single-authored docs	2
Co-Authors per Doc	4.4
International co-authorships %	42.86
DOCUMENT TYPES	
article	23
review	12

Fig. 3. Main information of literature

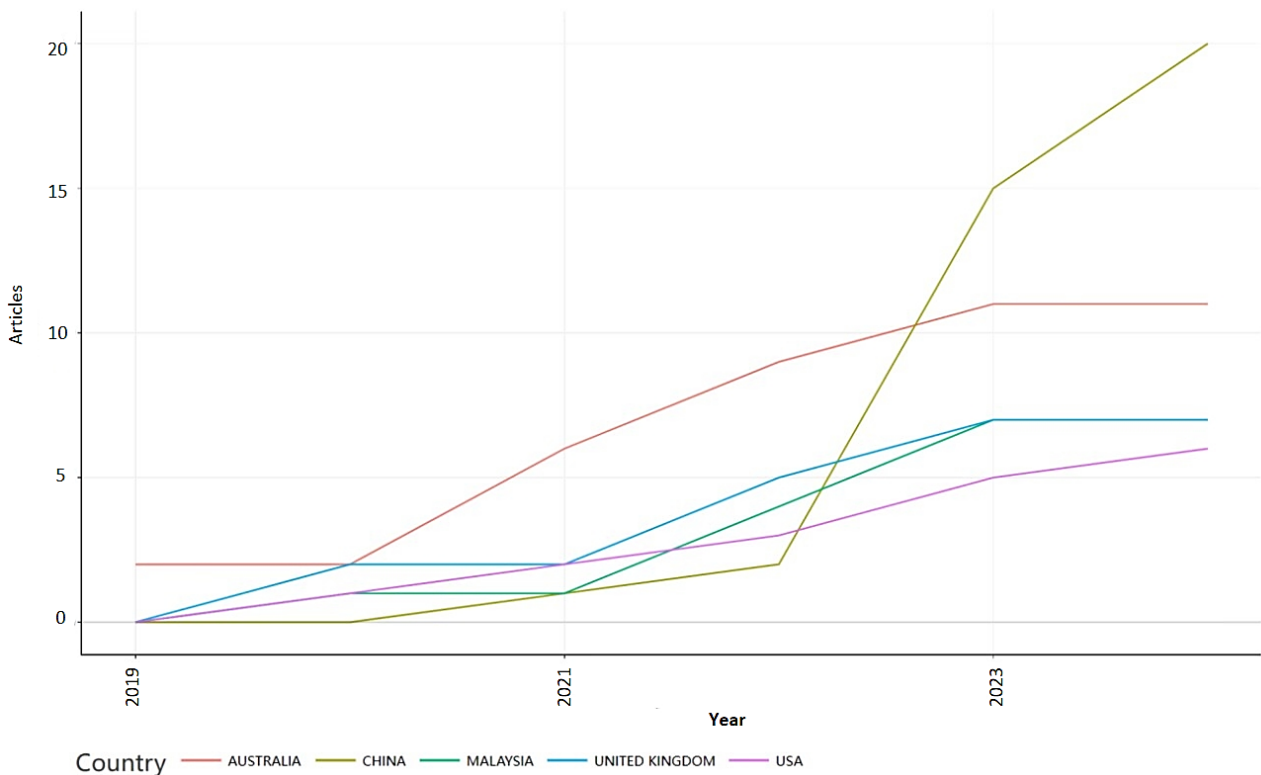

Fig. 4. Countries' Production over Time

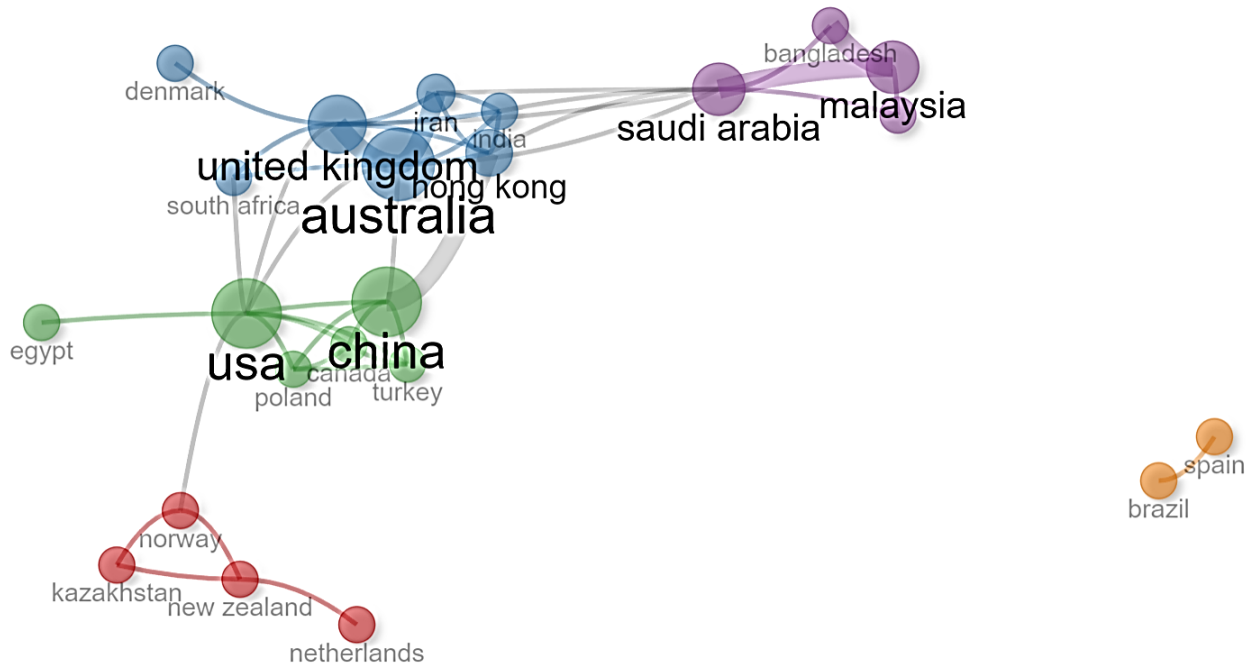

Fig. 5. Collaboration network of the countries

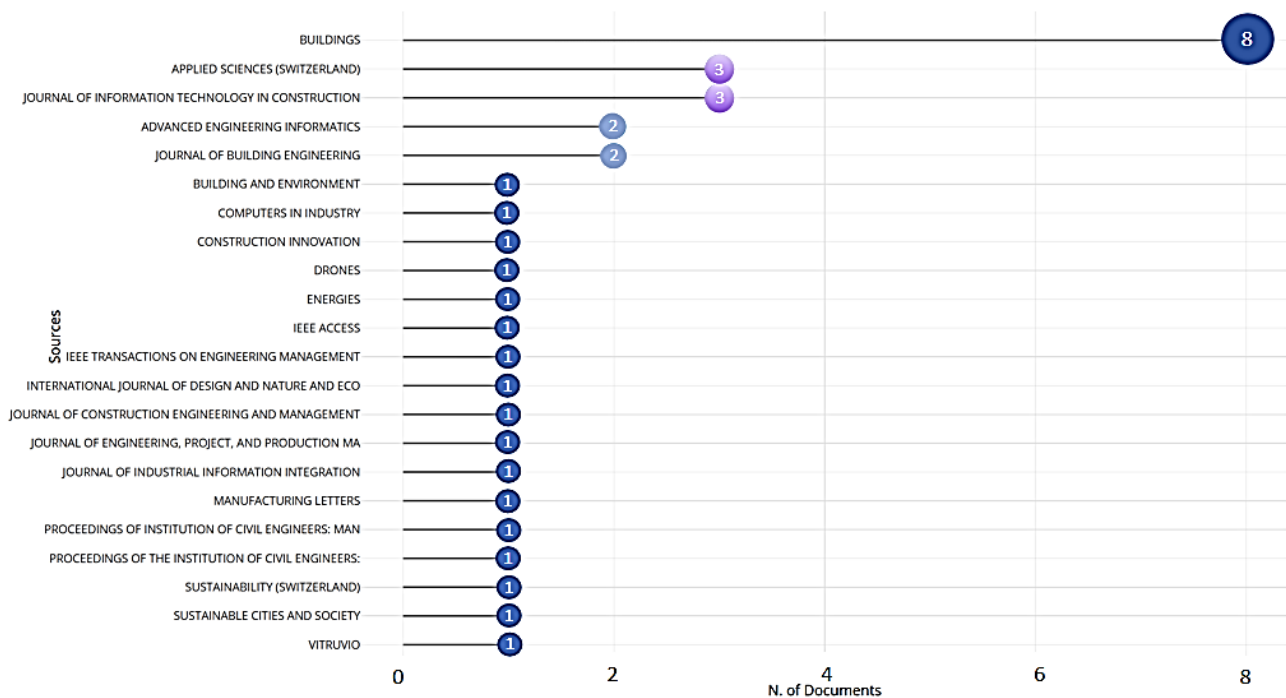

Fig. 6 Most Relevant Sources

In the co-occurrence network of topic analysis under conceptual structure, Figure 7 shows the development direction of DTs topics. The same topic type is represented by the same color. Figure 8 shows four areas that display the research topics. The lower right corner is the basic topics including the implementation of DTs, construction processes, engineering construction, etc.; the upper right corner is the mainstream topics including facility management, digitalization, sustainability, and decision analysis; the upper left corner is the professional topics including information models,

project investment, bibliometric analysis, education, etc.; in the lower left corner are emerging or declining topics including simulation, cloud computing, literature review, etc. The co-occurrence network of the above topic further verifies the necessity of this study.

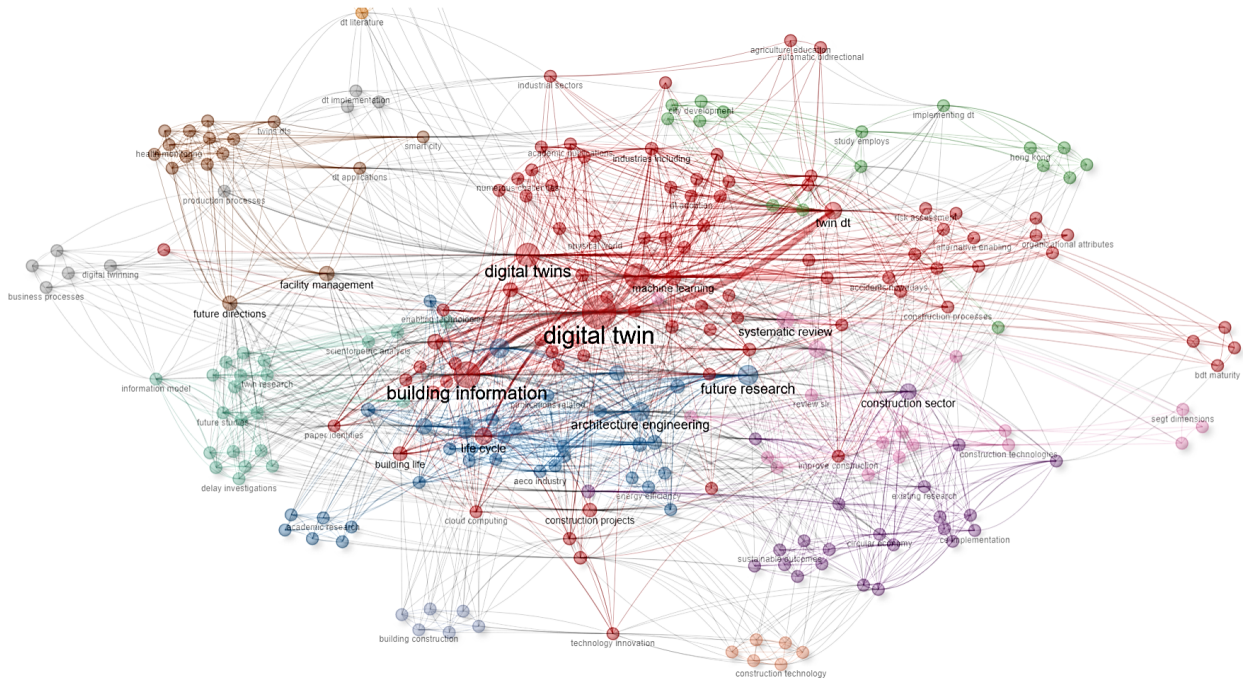

Fig. 7. Network visualization of the thematic

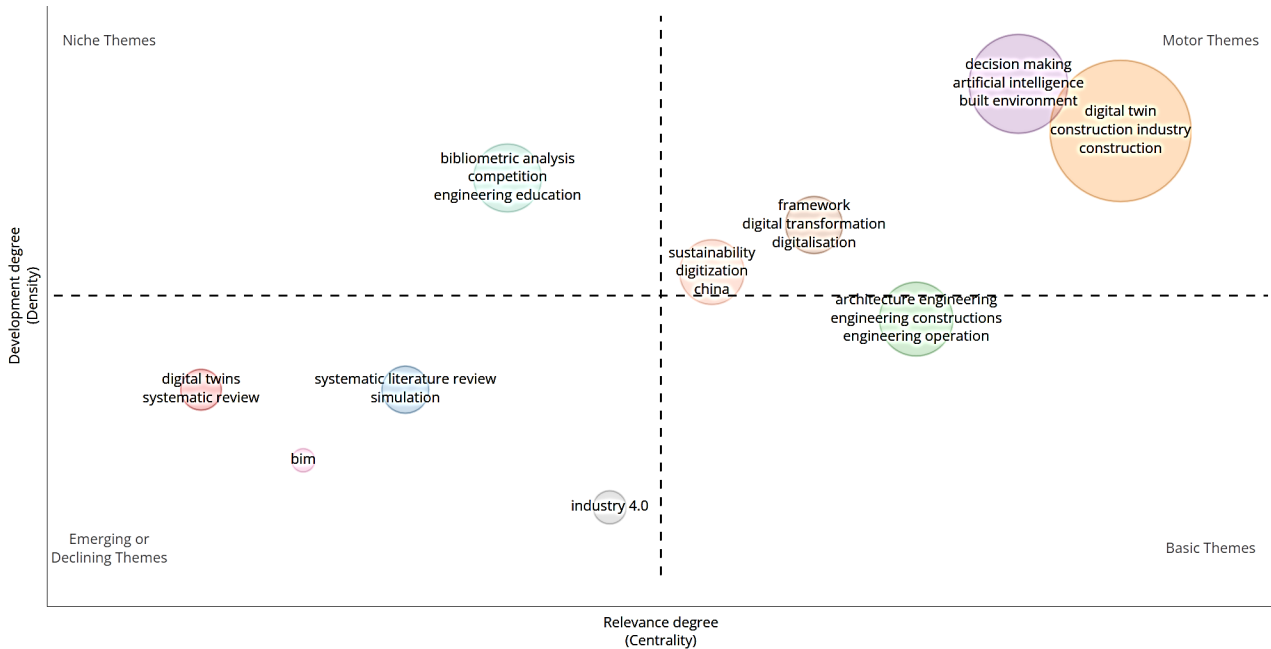

Fig. 8. Visualization map of the thematic

Figure 9 uses the co-occurrence of word pairs or noun phrases in a document to determine the connections between each subject in the research represented by the document set. The figure shows terms related to research topics, such as digital technology, digital tools, asset management, life cycle management, AI, and developing countries. The lines represent the connections between keywords.

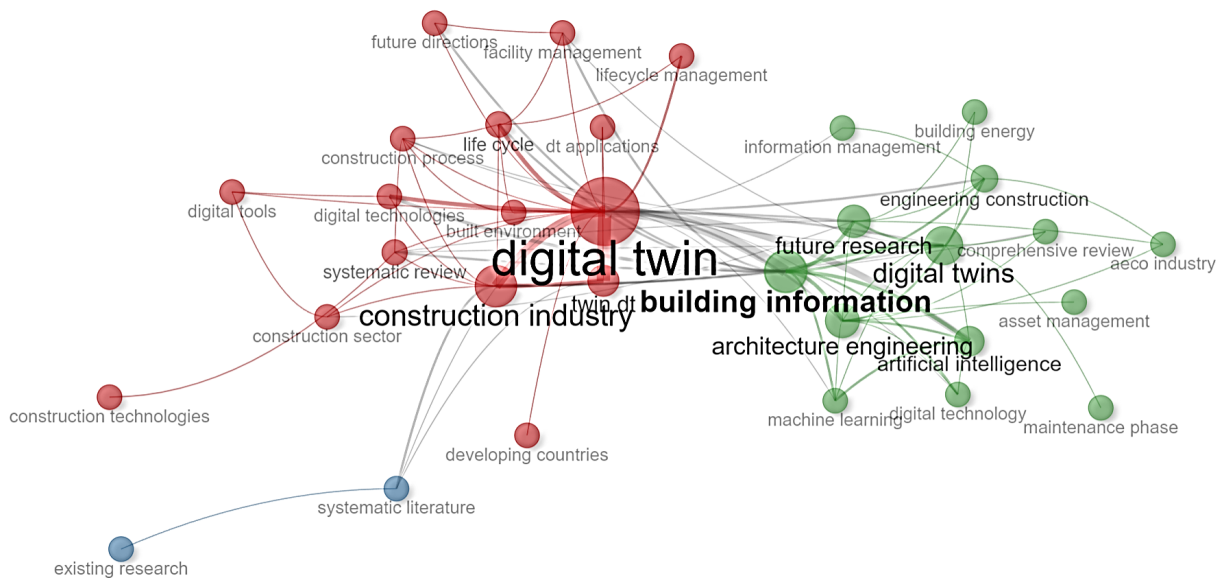

Fig. 9. Keywords co-occurrence network mapping

2.3 Category Selection

NVivo software was used to code the literature. The influencing factors of DTs implementation in the CI mentioned in the content were recorded in the Nvivo file, along with information about the articles cited. After scanning each paper and noting all influencing factors, duplicates were combined, and the total number of mentions for each factor was listed. Such findings “capture key elements of the phenomenon being described” [14]. The identified factor categories were organized using simple, typical, and descriptive coding with unambiguous labels. Through this process, four factor categories were identified, encompassing 13 key factors as shown in Table 3 under section 2.4.

2.4 Material Evaluation

Table 3 lists the identified factors and their classification and description.

Table 3
Factors Affecting DTs Implementation

Categories	Factors	References
Technology Factors	(F1) Integration of enablers	[5, 15-19]
Stakeholder Factors	(F2) Information management	[5, 16-18, 20-24]
Social Factors	(F3) System and processes	[16, 18, 25]
Economic Factors	(F4) Scalability issues	[16, 25, 26]
	(F5) Focus	[17, 18, 22, 27-29]
	(F6) Strategic decision	[16, 17, 30]
	(F7) Coordination	[8, 20, 31, 32]
	(F8) Performance assessment	[22, 30, 33-35]
	(F9) Guidelines and standards	[21, 29, 36, 37]
	(F10) Organization issues	[16, 17, 20, 34, 37, 38]
	(F11) Infrastructure and platform	[20, 22, 30, 39]
	(F12) Investment	[5, 16, 20, 27, 40]
	(F13) Production cost	[17, 18, 34, 38]

3. Systematic Analysis of the Factors for Implementing Dts in the CI from the Literature

The concept of using twin models can be traced back to the Apollo program of NASA, which produced two identical spacecrafts in the 1970s to replicate a ship's environment [41]. Regarding the definition of DTs, different development and research stages and research fields are not completely unified. According to the literature review, the key information reflected by the core vocabulary can be extracted, which represents the core part of the DTs - "virtual high-fidelity model, real-time simulation, dynamic feedback," which can reflect its role in simulation, diagnosis, optimization, the potential for prediction, control, decision-making, etc.

3.1 Technology Factors

Considering the requirements for its technology in the context of DTs, four factors were classified under this category, including integration of enablers, information management, system and processes, and scalability issues.

Integration of enablers: Initially, DTs were considered synonymous with BIM models in CI [23]. According to the definition of DTs, from the perspective of the "virtual high-fidelity model" created by DTs, compared with other 3D modelling software such as BIM, the biggest difference is that DTs require models to provide real-time feedback on dynamic data [35]. BIM is suitable for static data but not for real-time data. Although BIM and DTs have similarities, their purposes, technologies, end-users, and facility life stages differ. BIM technology can provide visual 3D communication for digital twins. The combination of BIM and wireless sensor networks (WSN) establishes a real-time active model as an application of digital twins in the construction industry, providing designers with effective information during the project design process [10]. The Internet of Things (IoT), sensors, and actuators have realized dynamic real-time feedback [42]. It is more accurate that "The basis of the integration of BIM and IoT has led to the emergence of Digital Twin' [5]. BIM cannot be equated with DTs and should be regarded as the first phase needed for DTs, and only as one of the enabling digital technologies of digital twins. In addition, DTs also include Machine Learning, Artificial Intelligence, Virtual/augmented reality, big data, and other technologies [42]. DTs are integrated platforms with embedded data that are capable of large-scale synchronization and management of data, information, and knowledge through the integration of enabling technologies. DTs are not just a technology or entity; they should be a platform that integrates a large number of physical objects, virtual models, and industrial systems. Each component of the platform is an integration of multiple technologies [8]. Some software, including Siemens NX, combines DTs physical simulation technology to bring 3D details into the system environment, and can easily integrate embedded control software and HMI design to support the use of physical system models to test the performance of embedded controls. This helps enterprises realize the value of digital twins. Provide next-generation design, simulation, and manufacturing solutions using an integrated toolset [13].

Information management: Owing to the integration of various technologies during the DTs implementation process, the needs or generation of different technologies exist in the form of data. Data-related aspects, including the acquisition, retrieval, generation, storage, sharing, and use of information, data management influencing data or dataset availability, data security, and data analysis, all belong to information management [43]. The previous study was considered that because of their high density, DTs require a large amount of data storage [20], and it was also pointed out that the volume of data collected creates the challenge of using this data to create intelligent models that enable facility managers to make decisions and take action in DTs implementation [21]. As early as 2021, studies have proposed that data loss during transmission could be brought on by

several circumstances, including data fading and software incompatibility caused by external environmental interference. Moreover, many kinds of IoT sensors gather the same or different kinds of environmental data, which may also bring some difficulties to the data analysis process [5]. Subsequent research has further clarified that the implementation of DTs requires high-quality data. If the data are unstable and unreliable and will run on erroneous and missing data, then the efficiency of DTs may be affected. The quality and quantity of IoT signals are key factors in digital twin information [37]. While ensuring data availability, many researchers report challenges around data security, a lack of trust in the data collected, and how to analyze and interpret these data in the right context and in the right way [21]. In the research description of DTs implementation barriers in [18], security issues are emphasized again, including reliability and robustness, providing minimal delay in reporting, tracking, and communication can be challenging uncertainty about accuracy levels, etc. [21].

System and processes: At the same time, implementing DTs poses problems to practitioners, especially decision makers. This is not only because of the above-mentioned need for digital technology integration, but also because of the complex production and procurement systems of the construction industry itself. Asset managers are resistant to incorporating new technology into management procedures as it currently now [44]. If DTs are implemented, communication is necessary regarding the modifications that need to be made to procedures, practices, and working methods. which can be offered for this purpose. DTs can serve as digital solutions for optimizing and streamlining operations [25].

Scalability issues: To date, it has taken more than a decade for the AECO-FM industry to adopt the digital twin concept [16]. Some studies predict that in upcoming studies, there will be numerous prospects for establishing O&M technologies related to digital twins (such as big data-based fault prediction and modelling with high accuracy and quick computation speed) [8]. This requires DTs to develop sustainably, and the speed of technology development will determine whether the expected drives and features of next-generation DTs can meet more aspects of construction applications.

3.2 Stakeholder Factors

Stakeholder factors include focus, strategic decisions, coordination, and performance assessment of the stakeholders in the CI.

Focus: As early as 2020, a study first analyzed the challenges faced by end users focusing on DTs implementation from the digital technology level, which pointed out the need for greater transparency and explainability to make decisions based on DTs [17]. Decision-makers implementing DTs focus on the conditions that support their decision making. Later, in the study by Bosch-Sijtsema *et al.*, [18], based on the knowledge and use of eleven digital technologies as of right now in AEC, including DTs, it was confirmed that the main obstacles to the implementation of new technologies mainly come from stakeholders' short-term focus on construction projects; while expectations may change as a result of new digital technology, they may also disrupt traditional practices or pose a threat to practitioners who believe that investment in innovation and possess an excessive amount of knowledge, making them less inclined to adopt new ideas. In subsequent research, from the perspective of the characteristics of the CI itself, in the face of construction projects that have become complex, quality standards have improved, and schedule burdens have increased, digitalization is still in its infancy, even if various enabling technologies are different from before. BIM has developed and improved rapidly, but the short-term thinking of decision makers in the CI still

leads to their reluctance to adopt digital technologies [22]. This shows that stakeholders' attention tendencies affect whether they adopt DTs.

Strategic decisions: The impact of this factor is reflected mainly in top management and leadership support. First, new innovative technologies have the possibility of speculation in the industry. A comprehensive judgment must be made regarding its actual development and whether it can be concretely transformed into feasible and effective technologies [18]. Second, during the entire process of implementation of DTs in the context of Architecture 4.0, the workflow is different from the previous one. It is impossible to isolate the role of each practitioner independently, and DT implementation requires cross-professional and interdisciplinary work. In combination, stakeholders are more afraid of the AEC's digital transformation because it involves new market participants and business models [22]. At the same time, they lack professionals around them to instill concepts and analyze trends, so it is difficult for decision-makers to make strategic decisions that subvert tradition and affect the implementation of DTs in the CI [18].

Coordination: Owing to the large number of participants in the CI, efficient and safe communication between them is crucial [8]. From the perspective of the project cycle, the inability to complete a project on time is one of the difficulties faced by builders. This is mainly caused by the combination of tasks and actions of the contractor, owner, or all stakeholders. The key to solving this problem is that it should be investigated from delay shifting to identifying preventive factors. Digital technologies, such as DTs, can be useful for this, but they often overlook this. The visibility, real-time monitoring, and flexibility of projects using wider digital technologies can mitigate the negative impacts of resource and coordination issues [33]. Following a 2021 study that suggested how DTs might assist in the design and construction of buildings and civil infrastructure, scholars and practitioners cannot agree. The following research extends the existing understanding of DTs in the CI, targeting the use of DTs in the CI. DTs information systems derive coherent, comprehensive, and actionable workflows for planning and controlling the design and construction of buildings and other facilities. The final study proposes a comprehensive framework for engineering processes with DTs information systems at its core, but primarily the design and construction phases of buildings and infrastructure [10]. In summary, the extent to which researchers and practitioners collaborate in DTs to support a coherent overall "digital twin" operation throughout phases through the process of construction life cycle affects the implementation of DTs.

Performance assessment: It can be seen from the literature review that previous research focused on the investigation and analysis of specific digital application technologies. In contrast, there is a lack of key information about how to improve project performance [32]. Therefore, for the performance brought about by the implementation of DTs, stakeholders have corresponding requirements and expectations. Existing research has mentioned that DTs can reduce greenhouse gas emissions, and that implementing DTs can improve project quality [16,10]. It has been proposed that projects applying digital technology win awards in competition units or are recognized in public contract competitions. Expanding the influence of enterprises, if a basis for promoting project performance based on intelligent digital technology can be provided, this will help establish a more effective organizational environment [45,43]. Developing overall effectiveness evaluations is crucial for convincing decision makers to use innovative technology [22].

3.3 External Factors

External factors include guidelines and standards, organizational issues, and infrastructure and platform.

Guidelines and standards: From a technical perspective, some research points out that, whether physics-based or design-based, the simulation of DTs from the initial concept to the final design requires a unified approach. Standardized methods promote usage, domain understanding, and information flow during all stages of DTs creation and use [37]. Without a unified standard modelling method and insufficient details, existing work and results cannot be replicated or improved by relevant researchers and practitioners, thus limiting the widespread use of the technology [29]. From an ethical perspective, guidelines, standards, and new or revised forms of construction contracts affect legal and ethical issues regarding usage, user and behavioral data collection, and integrity in the implementation of digital technologies [17].

Organizational issues: The first refers to the development of digital theme education (not professional digital technology). Research shows that in addition to the lack of skilled labor, there is also a lack of awareness and understanding of digital technology [46]. On the other hand, the democratization of technology should be encouraged to make it easier for academia and CI to use, such as pilot projects established with public investment. The data generated should be publicly available, and resources can be shared based on the results of pilot projects [36].

Infrastructure and platform: Research shows that the concept of DTs covers a wide range of content, from basic research to technology development to system integration stages [17]. Therefore, the functions and applications of DTs are limited by their technical computing capability and infrastructure. A good technical infrastructure is conducive to data sharing and communication and thus affects the implementation of DTs [20].

3.4 Economic Factors

Economic factors include investment and production costs.

Investment: The implementation of DTs in the CI still requires an initial cost in most cases. Stakeholders focus on the cost of implementing new technologies but often do not consider long-term savings and production costs. Especially in the case of financial scarcity, investment should be more cautious. Current business models hinder the implementation of DTs [22]; therefore, adaptive business models need to be adopted. The creation and ongoing maintenance costs of DTs of different complexities will vary, making the business case and return on investment analysis more complex. Every technology requires investment; therefore, choosing the right technology to leverage is critical to maximizing its efficiency [29].

Production cost: When the project life cycle is short, digital transformation can be costly and may not be an investment business are willing to make. Similar to other technologies, the high cost and difficulty of handling massive DTs datasets may be why DTs are not utilized in these nations. Furthermore, DTs also need to be continuously updated to reflect the advancements in the technological fields in which they are adopted, such as IoT and machine study. These technologies enable DTs to update themselves using incoming real-time data. Because digital transformation relies on rapidly evolving technologies, investments in digital transformation need to be ongoing, which results in higher long-term costs [29].

4. ISM Analyses and Results

After factor identification, ISM techniques were used to model the interrelationships of these factors. Warfield originally proposed ISM technology in the United States in 1973 [45]. The main objective was to extract the constituent elements of the research problem and use matrix tools and computer technology to process the elements and their interrelationship information. The purpose

was to clarify the hierarchical and overall structure of the elements to improve awareness and understanding of research issues. The analysis included the following steps:

Step1: identify the contextual relationship i, j between the multi-factors

First, to display the contextual link between components, an adjacency matrix was utilized, which involved 13 influencing factors. The multi-factor relationship is established mainly through content analysis of the literature review and the opinions of professionals on the mutual influence of factors i (row elements in the matrix) and j (column elements in the matrix). The results are presented in the form of an adjacency matrix A (Table 4), in which the influence relationships between elements (e.g., causal relationships, affiliation relationships, and comparison relationships) are represented by 1 or 0. If factor i can directly affect factor j , the (i, j) item in the adjacency matrix is 1; otherwise, it is 0. If factor i can be directly affected by factor j , the (j, i) item in the adjacent matrix is 1; otherwise, it is 0.

Table 4

The adjacency matrix of factors affecting the implementation of DTs in the construction industry

A	F1	F2	F3	F4	F5	F6	F7	F8	F9	F10	F11	F12	F13
F1	0	0	0	0	0	0	1	0	0	0	0	0	0
F2	0	0	0	0	0	0	1	0	0	0	1	1	0
F3	0	0	0	0	0	1	0	0	0	0	0	0	0
F4	0	0	0	0	0	0	1	0	0	0	0	0	0
F5	0	0	0	1	0	1	0	0	0	0	1	1	0
F6	0	0	0	0	0	0	0	0	0	0	0	0	0
F7	0	0	1	0	0	0	0	0	0	0	0	0	0
F8	0	0	0	0	0	0	0	0	1	1	0	1	0
F9	0	0	0	0	0	0	0	0	0	0	0	0	0
F10	0	0	0	0	0	0	0	0	0	0	0	1	0
F11	0	1	0	0	0	0	0	0	0	0	0	0	0
F12	0	0	1	0	0	0	1	0	0	0	0	0	0
F13	0	0	0	0	0	1	0	0	0	0	0	0	0

Step 2: Model Calculation

The matrix of adjacency only shows the connection of direct influence between variables but cannot show the indirect relationship between them. For example, if there is a direct impact on the relationship between factors i and j , it means that i can reach j . When there is no direct relationship between them, i may also reach j through other paths, and these paths show indirect relationships between factors. The reachability relationship composed of these is called the reachability matrix, which is represented by M : power iteration analysis based on the adjacency matrix is used to create the Reachability Matrix [46]. The following formula Eq. (1) can be used to calculate the reachability matrix:

$$M = (A + I)^r \tag{1}$$

When following the rules of Boolean operations, the value of r can be determined using software iterative operations until $(A+I)^r = (A+I)^{r+1}$. The study's reachability matrix is presented in Table 5 and Table 6. Meanwhile, the outcomes of the level divisions are presented in Table 7.

Table 5

Reachability matrix of variables influencing the implementation of DTs in the construction industry

M	F1	F2	F3	F4	F5	F6	F7	F8	F9	F10	F11	F12	F13
F1	1	0	1	0	0	1	1	0	0	0	0	0	0
F2	0	1	1	0	0	1	1	0	0	0	1	1	0
F3	0	0	1	0	0	1	0	0	0	0	0	0	0
F4	0	0	1	1	0	1	1	0	0	0	0	0	0
F5	0	1	1	1	1	1	1	0	0	0	1	1	0
F6	0	0	0	0	0	1	0	0	0	0	0	0	0
F7	0	0	1	0	0	1	1	0	0	0	0	0	0
F8	0	0	1	0	0	1	1	1	1	1	0	1	0
F9	0	0	0	0	0	0	0	0	1	0	0	0	0
F10	0	0	1	0	0	1	1	0	0	1	0	1	0
F11	0	1	1	0	0	1	1	0	0	0	1	1	0
F12	0	0	1	0	0	1	1	0	0	0	0	1	0
F13	0	0	0	0	0	1	0	0	0	0	0	0	1

Table 6

Reachability matrix of factors affecting the implementation of DTs in the construction industry

	F1	F2	F3	F4	F5	F6	F7	F8	F9	F10	F11	F12	F13
Driving-power	4	6	2	4	8	1	3	7	1	5	6	4	2
Dependence-	1	3	10	2	11	12	9	1	2	2	3	6	1

Table 7

The level partition between factors

Level	Factors
I	(F6) Strategic decision (F9) guidelines and standards
II	(F3) system and processes (F13) production cost
III	(F7) coordination
IV	(F1) Integration of enablers (F4) Scalability issues (F12) investment
V	(F2) information management (F10) organization issues (F11) infrastructure and platform
VI	(F5) Focus (F8) performance assessment

The above results were calculated using SPSSAU.

Step3: ISM diagram drawing

Using the information in Table 6, the ISM-based hierarchical structure among the 13 factors was obtained. Draw the ISM diagram based on the order of the factor selection and accessibility matrix. The diagram shows the interrelationship between different factors in the system, providing the reader with a graphical illustration, as shown in Figure 10.

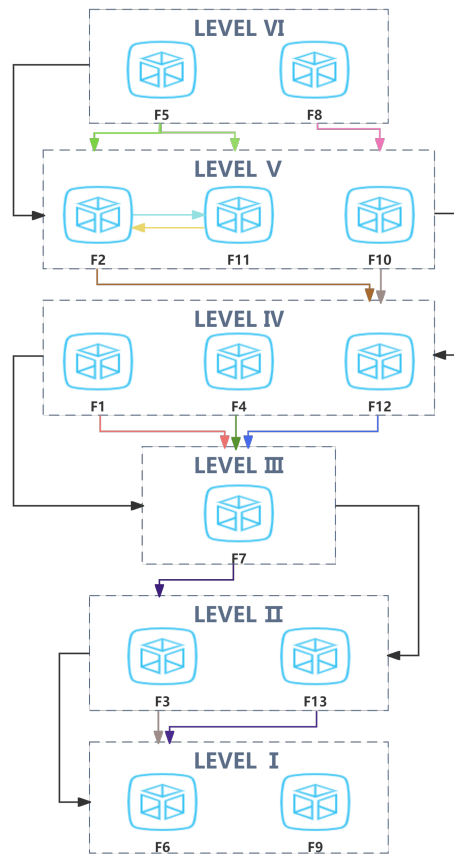

Fig. 10. ISM diagram of the factors

5. Discussion

According to the principle of the ISM analysis method and the above results, the discussion section is mainly divided into three modules: fundamental factors, result factors, and intermediate factors.

1. Fundamental factors, that is, those that affect other factors, are at the lowest level. According to the results of the above ISM analysis, it can be seen that the first two layers located in the ISM hierarchy diagram in Figure 10 include focus (F5), performance assessment (F8), information management (F2), organization issues (F10), and infrastructure platform (F11), indicating that to address these factors, priority measures and actions need to be implemented. F5 and F8 are located at the highest level of the hierarchical diagram, meaning that they have the greatest driving force for the implementation of DTs in the CI, have the greatest impact on initial decision-making, and should be given priority. Stakeholders usually pay only short-term attention to emerging technologies. They are usually not optimistic about technologies that require more than ten years of process because this means that the investment return period will be longer, and there will be no interest and confidence in adoption. Short- or long-term focus affects the decision to implement DTs, as this often requires a long-term perspective. When technology develops to a certain stage, it is not only the technical level that affects its implementation, but also the use of existing performance and the development of comprehensive performance evaluations to convince decision-makers to adopt advanced technologies. This is crucial, and it is recommended to summarize and promote the experience of DTs implementation and provide the information it brings about improving performance.

In addition, in the second layer, F2, F10, and F11 are also considered as three other important driving factors, which have a significant impact on several factors in the next layer. Because DT integrates multiple enabling technologies and requires a lot of computing resources and operations performed in a cloud computing environment [37], infrastructure will affect its application and role. At the same time, in the process of DT implementation, the availability of emerging data sets, data security, and data analysis make data management infrastructure the first obstacle that appears at the project level. However, the aforementioned problems are similar to the BIM implementation barriers faced by the AEC industry. Therefore, with industry experience in BIM implementation, the adoption of DT concepts may become easier [15]. At the same time, the government should also provide incentive policies and take the lead in improving infrastructure construction before requiring projects to adopt digital twin policies. On the basis of pilot projects established with public investment, construction resources and results will be publicly shared, digital theme education will be carried out to society, and practitioners and decision makers will be allowed to think about planning projects with digital thinking, which will help promote the implementation of digital twins in infrastructure construction.

2. Intermediate factor set, sending downward arrows to influence lower-level factors. The intermediate influencing factors of the ISM diagram: integration of enabling factors (F1), scalability issues (F4), coordination (F7), and investment (F12) are considered intermediate factors. These factors are not strong drivers of the other factors. The development of these four factors is also less dependent on the factor system. Therefore, these are relatively stable factors. These changes do not lead to comprehensive changes in the system. In the long run, they are in the middle of the incremental hierarchy of the entire system, are affected by the root layer, and act as presentation hubs that connect the upper and lower levels. These factors can be prioritized appropriately [46].

3. The resulting layer factors have the following characteristics and are affected by other factors. (F3), and strategic decisions (F6). Lower-level factors can be regarded as result-layer influencing factors. However, they were still affected by high-level driving factors. If the previous driving factors improve, the influence of these dependent factors also improves. In summary, the five main driving factors at a high level, F2, F5, F8, F10, and F11, should be prioritized over the four dependent factors at a low level, F3, F6, F9, and F13.

6. Conclusions

With the rapid development of Industry 4.0, the beginning of Construction 4.0 has been promoted. The construction industry has entered the digital transformation era, and digital technology has been used to change the backward status quo of the CI. DTs are a key digital technology for the CI to improve production efficiency and quality, but their implementation in the CI is still not widespread. Many factors affect its implementation. Previous studies have discussed the driving factors and obstacles affecting the implementation of DTs in the CI. However, the relationship between these factors has not been further verified and discussed. This study first found 13 representative influencing factors through a systematic literature review and then constructed a hierarchical structure of these factors through the ISM method, divided into six levels. The final hierarchical results are presented in the form of an ISM diagram. The results show that factors such as focus (F5) and performance assessment (F8) have a strong driving effect on the implementation of DTs in the CI and should be given more attention. Practitioners should first pay attention to these factors in their projects. Understanding these representative factors and hierarchical structures can provide practitioners with meaningful guidance in implementing DTs. If these factors are effectively

solved, DTs are expected to be adopted more in the CI and play a greater role. The findings will support practitioners in CI using or planning to use DTs.

Acknowledgment

This research was not funded by any grant.

References

- [1] Wong, Peter SP, Charles Zwar, and Ehsan Gharai. "Examining the drivers and states of organizational change for greater use of prefabrication in construction projects." *Journal of construction engineering and management* 143, no. 7 (2017): 04017020. [https://doi.org/10.1061/\(asce\)co.1943-7862.0001309](https://doi.org/10.1061/(asce)co.1943-7862.0001309)
- [2] Forcael, Eric, Isabella Ferrari, Alexander Opazo-Vega, and Jesús Alberto Pulido-Arcas. "Construction 4.0: A literature review." *Sustainability* 12, no. 22 (2020): 9755. <https://doi.org/10.3390/su12229755>
- [3] Hu, Wei, Kendrick Yan Hong Lim, and Yiyu Cai. "Digital twin and industry 4.0 enablers in building and construction: a survey." *Buildings* 12, no. 11 (2022): 2004. <https://doi.org/10.3390/buildings12112004>
- [4] Liu, Chuncheng, and Ying Tian. "Recognition of digital twin city from the perspective of complex system theory: Lessons from Chinese practice." *Journal of Urban Management* 12, no. 2 (2023): 182-192. <https://doi.org/10.1016/j.jum.2023.04.001>
- [5] Deng, Min, Carol C. Menassa, and Vineet R. Kamat. "From BIM to digital twins: A systematic review of the evolution of intelligent building representations in the AEC-FM industry." *Journal of Information Technology in Construction* 26 (2021). <https://doi.org/10.36680/j.itcon.2021.005>
- [6] Turner, Christopher J., John Oyekan, Lampros Stergioulas, and David Griffin. "Utilizing industry 4.0 on the construction site: Challenges and opportunities." *IEEE Transactions on Industrial Informatics* 17, no. 2 (2020): 746-756. <https://doi.org/10.1109/tii.2020.3002197>
- [7] Khajavi, Siavash H., Naser Hossein Motlagh, Alireza Jaribion, Liss C. Werner, and Jan Holmström. "Digital twin: vision, benefits, boundaries, and creation for buildings." *IEEE access* 7 (2019): 147406-147419. <https://doi.org/10.1109/access.2019.2946515>
- [8] Su, Shuaiming, Ray Y. Zhong, Yishuo Jiang, Jidong Song, Yang Fu, and Hongrui Cao. "Digital twin and its potential applications in construction industry: State-of-art review and a conceptual framework." *Advanced Engineering Informatics* 57 (2023): 102030. <https://doi.org/10.1016/j.aei.2023.102030>
- [9] Seuring, Stefan, and Stefan Gold. "Conducting content-analysis based literature reviews in supply chain management." *Supply chain management: An international journal* 17, no. 5 (2012): 544-555. <https://doi.org/10.1108/13598541211258609>
- [10] Opoku, De-Graft Joe, Srinath Perera, Robert Osei-Kyei, and Maria Rashidi. "Digital twin application in the construction industry: A literature review." *Journal of Building Engineering* 40 (2021): 102726. <https://doi.org/10.1016/j.jobe.2021.102726>
- [11] Santos, Rúben, António A. Costa, and António Grilo. "Bibliometric analysis and review of Building Information Modelling literature published between 2005 and 2015." *Automation in Construction* 80 (2017): 118-136. <https://doi.org/10.1016/j.autcon.2017.03.005>
- [12] Kritzinger, Werner, Matthias Karner, Georg Traar, Jan Henjes, and Wilfried Sihn. "Digital Twin in manufacturing: A categorical literature review and classification." *Ifac-PapersOnline* 51, no. 11 (2018): 1016-1022. <https://doi.org/10.1016/j.ifacol.2018.08.474>
- [13] Qi, Qinglin, Fei Tao, Tianliang Hu, Nabil Anwer, Ang Liu, Yongli Wei, Lihui Wang, and Andrew YC Nee. "Enabling technologies and tools for digital twin." *Journal of Manufacturing Systems* 58 (2021): 3-21. <https://doi.org/10.1016/j.jmsy.2019.10.001>
- [14] Allen, Mike, ed. *The SAGE encyclopedia of communication research methods*. SAGE publications, 2017. <https://doi.org/10.4135/9781483381411>
- [15] Zabidin, Nadia Safura, Sheila Belayutham, and Che Khairil Izam Che Ibrahim. "A bibliometric and scientometric mapping of Industry 4.0 in construction." *J. Inf. Technol. Constr.* 25 (2020): 287-307. <https://doi.org/10.36680/j.itcon.2020.017>
- [16] Ozturk, Gozde Basak. "Digital twin research in the AECO-FM industry." *Journal of Building Engineering* 40 (2021): 102730. <https://doi.org/10.1016/j.jobe.2021.102730>
- [17] Rasheed, Adil, Omer San, and Trond Kvamsdal. "Digital twin: Values, challenges and enablers from a modeling perspective." *IEEE access* 8 (2020): 21980-22012. <https://doi.org/10.1109/ACCESS.2020.2970143>
- [18] Bosch-Sijtsema, Petra, Christina Claeson-Jonsson, Mikael Johansson, and Mattias Roupe. "The hype factor of digital technologies in AEC." *Construction Innovation* 21, no. 4 (2021): 899-916. <https://doi.org/10.1108/ci-01-2020-0002>

- [19] Kineber, Ahmed Farouk, Atul Kumar Singh, Abdulwahed Fazeli, Saeed Reza Mohandes, Clara Cheung, Mehrdad Arashpour, Obuks Ejowomu, and Tarek Zayed. "Modelling the relationship between digital twins implementation barriers and sustainability pillars: Insights from building and construction sector." *Sustainable Cities and Society* 99 (2023): 104930. <https://doi.org/10.1016/j.scs.2023.104930>
- [20] Junjia, Yin, Aidi Hizami Alias, Nuzul Azam Haron, and Nabilah Abu Bakar. "A Bibliometrics-Based systematic review of safety risk assessment for IBS hoisting construction." *Buildings* 13, no. 7 (2023): 1853. <https://doi.org/10.3390/buildings13071853>
- [21] Bortolini, R., R. Rodrigues, H. Alavi, L. F. D. Vecchia, and N. Forcada. *Digital Twins' Applications for Building Energy Efficiency: A Review*. *Energies* 2022, 15, 7002. 2022. <https://doi.org/10.3390/en15197002>
- [22] Shafei, Hazwani, Afiqah R. Radzi, Mohammed Algahtany, and Rahimi A. Rahman. "Construction 4.0 technologies and decision-making: A systematic review and gap analysis." *Buildings* 12, no. 12 (2022): 2206. <https://doi.org/10.3390/buildings12122206>
- [23] Opoku, De-Graft Joe, Srinath Perera, Robert Osei-Kyei, and Maria Rashidi. "Digital twin application in the construction industry: A literature review." *Journal of Building Engineering* 40 (2021): 102726. <https://doi.org/10.1016/j.jobe.2021.102726>
- [24] Bunjaridh, Yuveelai, Rahimi A. Rahman, and Liyana Mohamed Yusof. "Digital Twin Production in the Architecture, Engineering, Construction and Operation Industry: Organizational Attributes and Strategies." *Journal of Engineering, Project & Production Management* 13, no. 3 (2023). <https://doi.org/10.32738/JEPPM-2023-0019>
- [25] Khallaf, Rana, Lama Khallaf, Chimay J. Anumba, and Obinna C. Madubuike. "Review of digital twins for constructed facilities." *Buildings* 12, no. 11 (2022): 2029. <https://doi.org/10.3390/buildings12112029>
- [26] Dou, Yudan, Tianxin Li, Long Li, Yuanxin Zhang, and Zhongfu Li. "Tracking the research on ten emerging digital technologies in the AECO industry." *Journal of Construction Engineering and Management* 149, no. 3 (2023): 03123003. <https://doi.org/10.1061/JCEMD4.COENG-12290>
- [27] Gómez, Cristian Camilo Osorio, Rodrigo Herrera, Eugenio Pellicer, Alejandro Alzate Buitrago, and Daniel Aristizabal-Torres. "Construction 4.0: Cluster analysis and Research perspectives." *Revista ingeniería de construcción* (2023). <https://doi.org/10.7764/ric.00083.21>
- [28] Oyewobi, Luqman, Taofeek Tunde Okanlawon, Kabir Ibrahim, and Richard Ajayi Jimoh. "Influence of blockchain adoption barriers and drivers on potential application areas in the construction lifecycle: partial least squares structural equation modelling (PLS-SEM) approach." *Engineering, Construction and Architectural Management* (2023) . <https://doi.org/10.1108/ECAM-07-2023-0746>
- [29] Wooley, Ana, Daniel F. Silva, and Julia Bitencourt. "When is a simulation a digital twin? A systematic literature review." *Manufacturing Letters* 35 (2023): 940-951. <https://doi.org/10.1016/j.mfglet.2023.08.014>
- [30] Opoku, De-Graft Joe, Srinath Perera, Robert Osei-Kyei, Maria Rashidi, Tosin Famakinwa, and Keivan Bamdad. "Drivers for digital twin adoption in the construction industry: A systematic literature review." *Buildings* 12, no. 2 (2022): 113. <https://doi.org/10.3390/buildings12020113>
- [31] Moretti, Nicola, Xiang Xie, Jorge Merino Garcia, Janet Chang, and Ajith Kumar Parlikad. "Federated data modeling for built environment digital twins." *Journal of Computing in Civil Engineering* 37, no. 4 (2023): 04023013. <https://doi.org/10.1061/jccee5.Cpeng-4859>
- [32] Kim, Taehoon, Hyunsu Lim, Myungdo Lee, Minsu Cha, and Kyuman Cho. "Performance-Influencing Factors and Causal Relationships of Construction Projects Using Smart Technology." *Buildings* 13, no. 6 (2023): 1431. <https://doi.org/10.3390/buildings13061431>
- [33] Sepasgozar, Samad ME, Reyhaneh Karimi, Sara Shirowzhan, Mohammad Mojtahedi, Sabbar Ebrahimzadeh, and David McCarthy. "Delay causes and emerging digital tools: A novel model of delay analysis, including integrated project delivery and PMBOK." *Buildings* 9, no. 9 (2019): 191. <https://doi.org/10.3390/buildings9090191>
- [34] Geoghegan, Hugh James, Frederik Winther Jensen, Tristan Kershaw, and Ricardo Codinhoto. "Innovation Realisation for Dutch Small Architecture Practices' Digitalisation: State of the art review." *Manag. Procure Law* 176 (2023): 176-191. <https://doi.org/10.1680/jmapl.22.00018>
- [35] Hou, Lei, Shaoze Wu, Guomin Zhang, Yongtao Tan, and Xiangyu Wang. "Literature review of digital twins applications in construction workforce safety." *Applied Sciences* 11, no. 1 (2020): 339. <https://doi.org/10.3390/app11010339>
- [36] Schimanski, Christoph Paul, Gabriele Pasetti Monizza, Carmen Marcher, and Dominik T. Matt. "Pushing digital automation of configure-to-order services in small and medium enterprises of the construction equipment industry: A design science research approach." *Applied Sciences* 9, no. 18 (2019): 3780. <https://doi.org/10.3390/app9183780>
- [37] Waqar, Ahsan, Idris Othman, Hamad Almujibah, Muhammad Basit Khan, Saleh Alotaibi, and Adil AM Elhassan. "Factors influencing adoption of digital twin advanced technologies for smart city development: Evidence from Malaysia." *Buildings* 13, no. 3 (2023): 775. <https://doi.org/10.3390/buildings13030775>

- [38] Jemal, Kebir Mohammed, Marzhan Kabzhassarova, Ramazan Shaimkhanov, Dinara Dikhanbayeva, Ali Turkyilmaz, Serdar Durdyev, and Ferhat Karaca. "Facilitating circular economy strategies using digital construction tools: framework development." *Sustainability* 15, no. 1 (2023): 877. <https://doi.org/10.3390/su15010877>
- [39] Li, Lingyue, Lie Wang, and Xiaohu Zhang. "Technology innovation for sustainability in the building construction industry: An analysis of patents from the Yangtze River Delta, China." *Buildings* 12, no. 12 (2022): 2205. <https://doi.org/10.3390/buildings12122205>
- [40] Maskuriy, Raihan, Ali Selamat, Kherun Nita Ali, Petra Maresova, and Ondrej Krejcar. "Industry 4.0 for the construction industry—how ready is the industry?." *Applied Sciences* 9, no. 14 (2019): 2819. <https://doi.org/10.3390/app9142819>
- [41] Chen, Bai-Qiao, Paulo M. Videiro, and C. Guedes Soares. "Opportunities and challenges to develop digital twins for subsea pipelines." *Journal of Marine Science and Engineering* 10, no. 6 (2022): 739. <https://doi.org/10.3390/jmse10060739>
- [42] Perno, Matteo, Lars Hvam, and Anders Haug. "Implementation of digital twins in the process industry: A systematic literature review of enablers and barriers." *Computers in Industry* 134 (2022): 103558. <https://doi.org/10.1016/j.compind.2021.103558>
- [43] Alonso, Rubén, Mikel Borrás, Rembrandt HEM Koppelaar, Alessandro Lodigiani, Eduard Loscos, and Emre Yöntem. "SPHERE: BIM digital twin platform." In *Proceedings*, vol. 20, no. 1, p. 9. MDPI, 2019. <https://doi.org/10.3390/proceedings2019020009>
- [44] Ahmad, Tengku Noradeena Tengku, and Siti Zaleha Abd Rasid. "Implementation of Building Maintenance Management System in an Organization." *Journal of Advanced Research in Technology and Innovation Management* 1, no. 1 (2021): 1-8.
- [45] Jain, Vijay Kumar, Vikas Arya, and Preeti Sharma. "Social media and sustainable behavior: A decision making framework using interpretive structural modeling (ISM)." *Journal of Content Community & Communication* 14 (2021): 1-13. <https://doi.org/10.31620/JCCC.12.21/07>
- [46] Shen, Liyin, Xiangnan Song, Ya Wu, Shiju Liao, and Xiaoling Zhang. "Interpretive Structural Modeling based factor analysis on the implementation of Emission Trading System in the Chinese building sector." *Journal of Cleaner Production* 127 (2016): 214-227. <https://doi.org/10.1016/j.jclepro.2016.03.151>